

# CanPro.

## Ophthalmic Instruments





Product Catalog

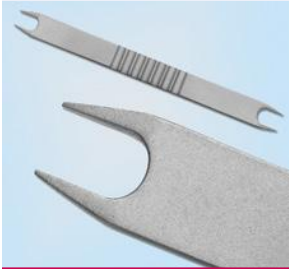
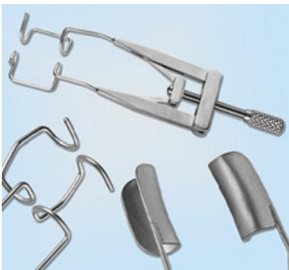

**Let The Life Glow With CanPro.**

# Ophthalmic Instruments

## Table of Contents

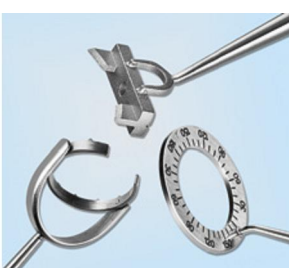
	Calipers	4
	Speculums	5 - 7
	Retractors	7 - 9
	Depressors	9
	Hooks/Manipulators	10 - 22
	Fixation Rings/Markers	23 - 25

Scissors

25 - 36

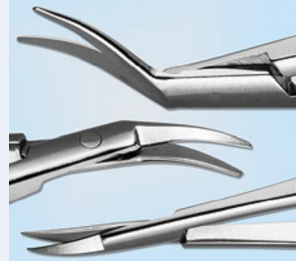

Forceps

36 - 44



Needle Holders

45 - 48



Dilator/Lacrimal Probes

47 - 48

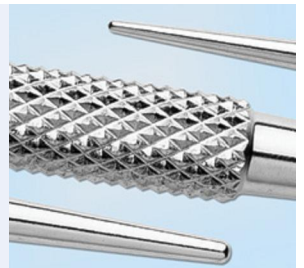

Cannulas

49 - 56

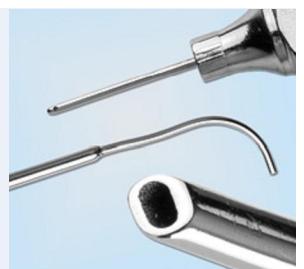

Miscellaneous

57



# Ophthalmic Instruments

## Calipers



MA001R

1/1



MA002R

1/1

### BRAUNSTEIN Calipers

MA001R

3.5/4.0 mm, 2<sup>3</sup>/<sub>4</sub>"

MA002R

3.0/3.5 mm, 2<sup>3</sup>/<sub>4</sub>"

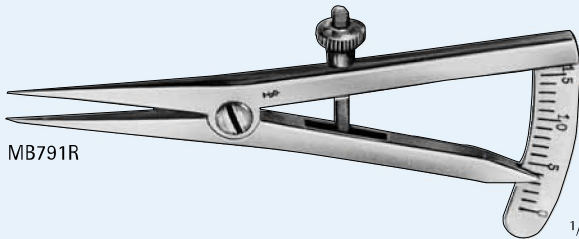

MB791R

1/1

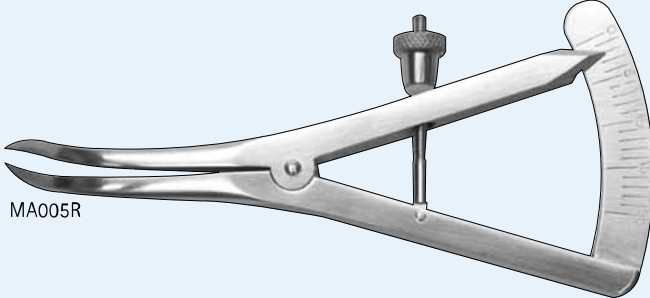

MA005R

1/1

### CASTROVIEJO Eye Calipers

MB791R

Straight, Range 0–15 mm, 3<sup>1</sup>/<sub>8</sub>"

MA005R

Curved, Range 0–20 mm, 3<sup>1</sup>/<sub>8</sub>"

# Speculums



## BARRAQUER Eye Speculums

**MA751R**  
10 mm Blades, 1 1/2"

**OA200R**  
14 mm Blades, 1 3/4"

**MA752R**  
Heavy Wire, 14 mm, 1 3/4"

**MA754R**  
15 mm Solid Blades, 1 3/4"

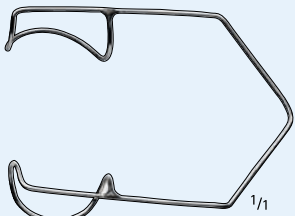

MA751R

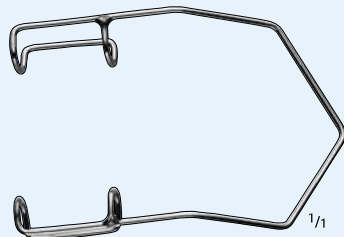

MA752R

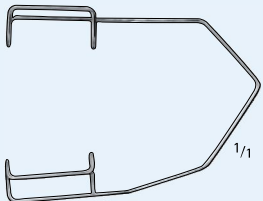

OA200R

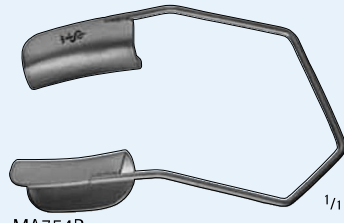

MA754R

## KRATZ-BARRAQUER Eye Speculums

**MA756R**  
Pediatric, 10 mm, 1 3/8"

**MA755R**  
14 mm Blades, 1 1/2"

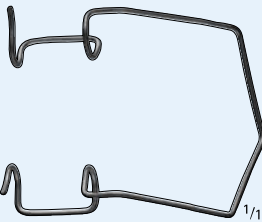

MA756R

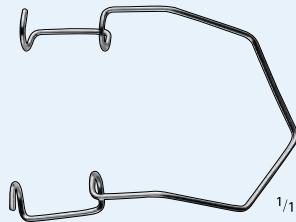

MA755R

## ALPHONSO Infant Speculum

**MA757R**  
5 mm & 9 mm wide x 7mm deep Blades, 1 3/4"

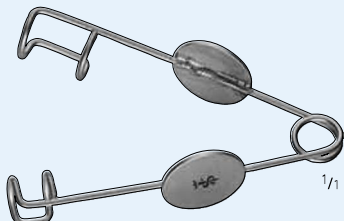

MA757R

# Ophthalmic Instruments

## Speculums

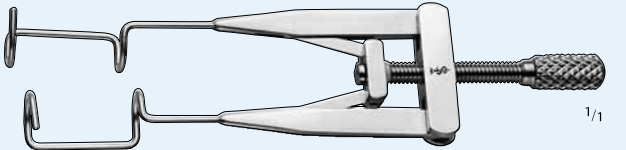

MA750R

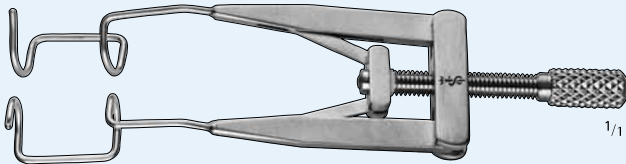

MA758R

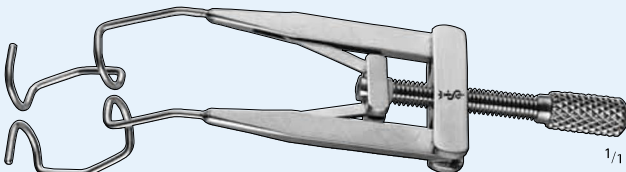

MA759R

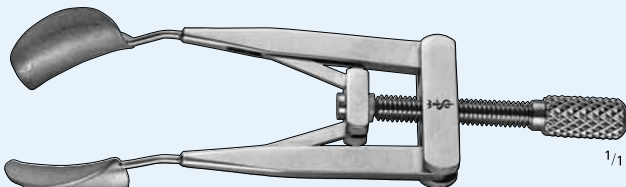

MA760R

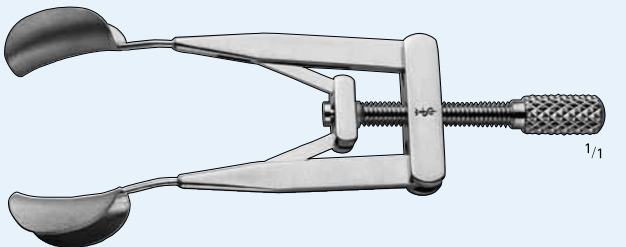

MA764R

### LIEBERMAN Adjustable Speculums

#### MA750R

Straight, 16 mm Square Wire Blades, 3 1/8"

#### MA758R

Angled, 14 mm Square Wire Blades, 3 1/4" Length

#### MA759R

Angled, 14 mm V-Shaped Wire Blades, 3 1/4" Length

#### MA760R

Angled, 14 mm Solid Blades, 3 1/4" Length

#### MA764R

Reversible, Angled, 14 mm Solid Blades, 3 1/8"

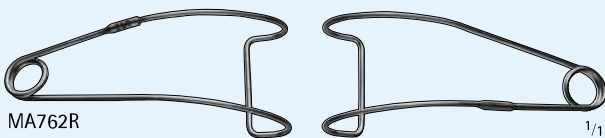

MA762R

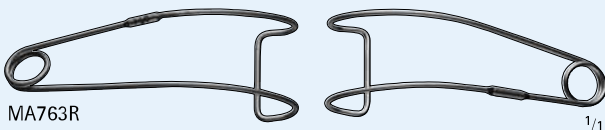

MA763R

### JAFFE Wire Lid Retractors

#### MA762R

15 mm Blades, Pair, 1 1/2"

#### MA763R

13 mm Blades, Pair, 1 1/2"

# Speculums

## SAUER Eye Speculums

**OA218R**  
11 mm Blades, 1<sup>3</sup>/<sub>8</sub>"

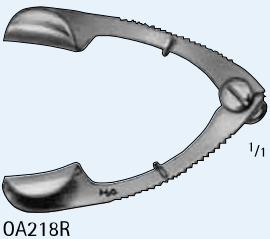

## LANCASTER Eye Speculum

**OA225R**  
15 mm Wide, x 7 mm Deep, 3<sup>1</sup>/<sub>8</sub>"

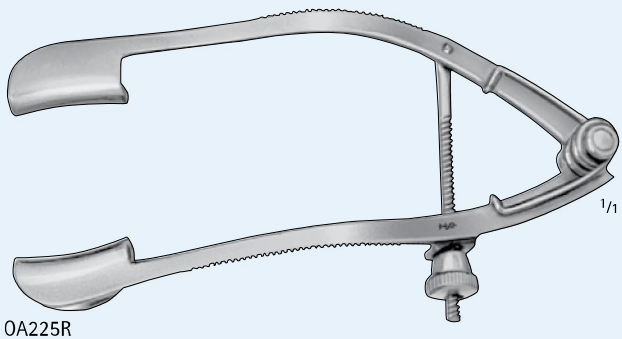

# Retractors

## DESMARRES Lid Retractors

**OA310R**  
9 x 9 mm, 5<sup>1</sup>/<sub>2</sub>"



**OA311R**  
9 x 12 mm, 5<sup>1</sup>/<sub>2</sub>"



**OA312R**  
11 x 14 mm, 5<sup>1</sup>/<sub>2</sub>"

OA310R

OA311R

OA312R

**OA313R**  
12 x 16 mm, 5<sup>1</sup>/<sub>2</sub>"



OA313R

OA314R

**OA314R**  
13 x 18 mm, 5<sup>1</sup>/<sub>2</sub>"



# Ophthalmic Instruments

## Retractors

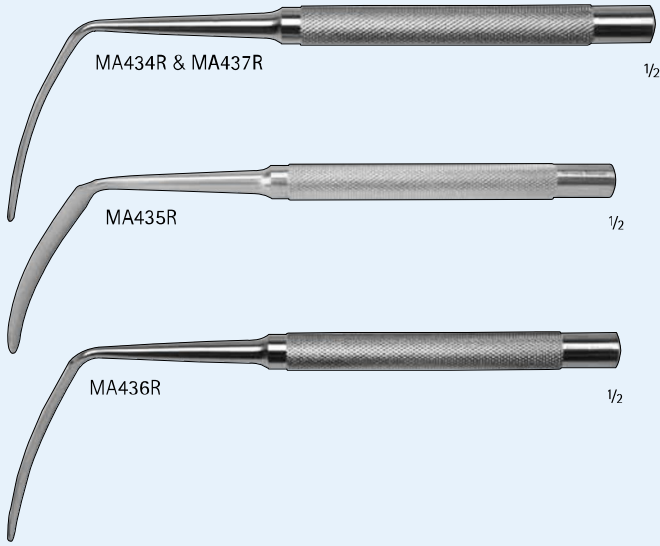

### SEWALL Orbital Retractors

#### MA434R

7 x 52 mm Blade, 6<sup>3</sup>/<sub>4</sub>"

#### MA435R

9 x 44 mm Blade, 6<sup>3</sup>/<sub>8</sub>"

#### MA436R

11 x 50 mm Blade, 6<sup>3</sup>/<sub>8</sub>"

#### MA437R

13 x 67 mm Blade, 6<sup>3</sup>/<sub>4</sub>"



### SCHEPENS Orbital Retractor

#### MA749R

Smooth, 14 x 61 Blade, 6<sup>1</sup>/<sub>8</sub>"



### JAEGER Lid Plate

#### MA765

Clear Plastic, 20 mm / 23 mm Wide, 3<sup>3</sup>/<sub>4</sub>"

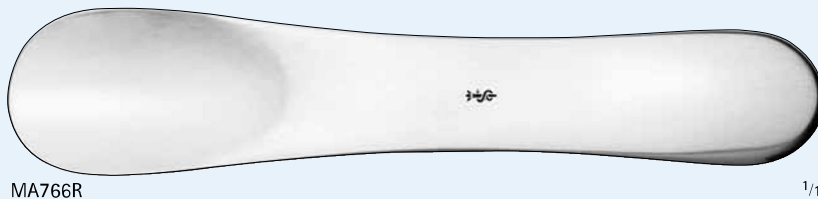

### BERKE-JAEGER Lid Plate

#### MA766R

20 mm / 30 mm Wide, 4<sup>1</sup>/<sub>4</sub>"

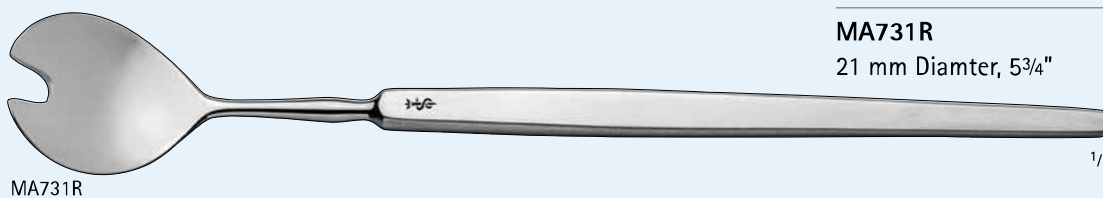

### WELLS Enucleation Spoon

#### MA731R

21 mm Diamter, 5<sup>3</sup>/<sub>4</sub>"



## Retractors

### BUNGE Evisceration Spoons

#### MA744R

Small, 8 mm Diameter, 5 1/4"

#### MA745R

Large, 12 mm Diameter, 5 1/2"

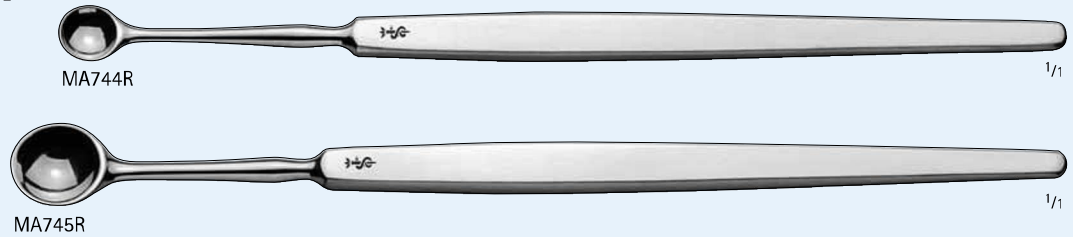

## Depressors

### SCHOCKET Scleral Depressor

#### MA761R

Double Ended, with Pocket Clip, 5 1/4"

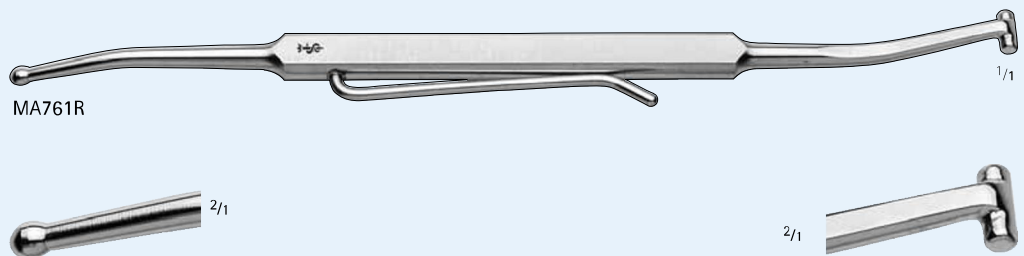

### FLYNN Scleral Depressor

#### MA747R

5 mm Diameter Loop, 3 1/8"

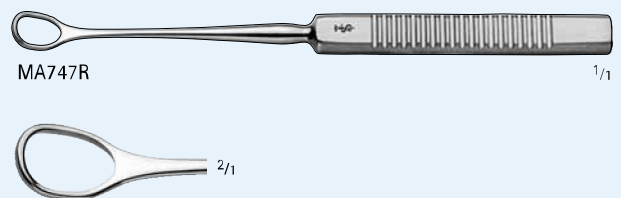

# Ophthalmic Instruments

## Hooks/Manipulators

### WHITMAN SHEPHERD Capsule Polisher

MA777R

Double Ended, Left Angled, Right Angled, 5 1/8"

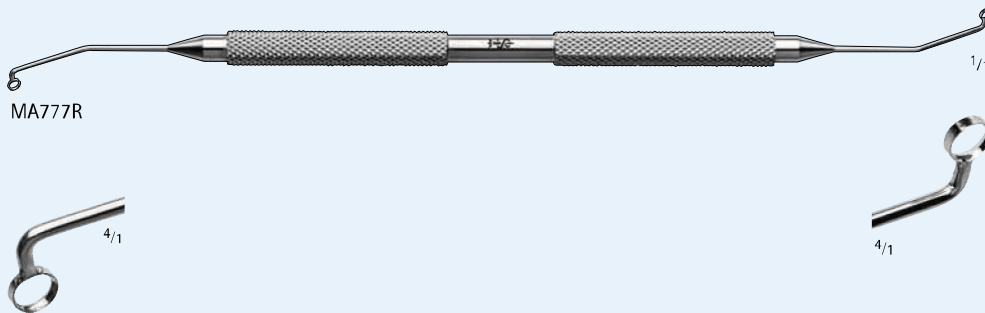

### KOCH Stop and Chop Manipulator

MA778R

Angled Shaft with 1.5 mm Tip, 4 3/4"

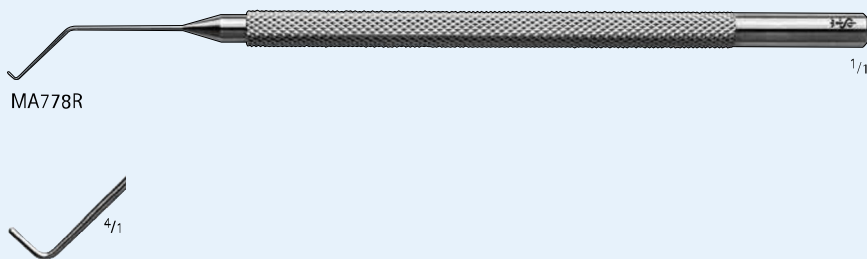

### CAMELLIN-style LASEK Alcohol Well

MA779R

8.5 mm Diameter, 4 1/2"





## SLOANE LASEK Spatulas

### MA780R

Micro Hoe, Semicircular Tip, Beveled Edge, 4 1/2"

### MA781R

Epi Peeler, Semi Sharp, 4 1/2"

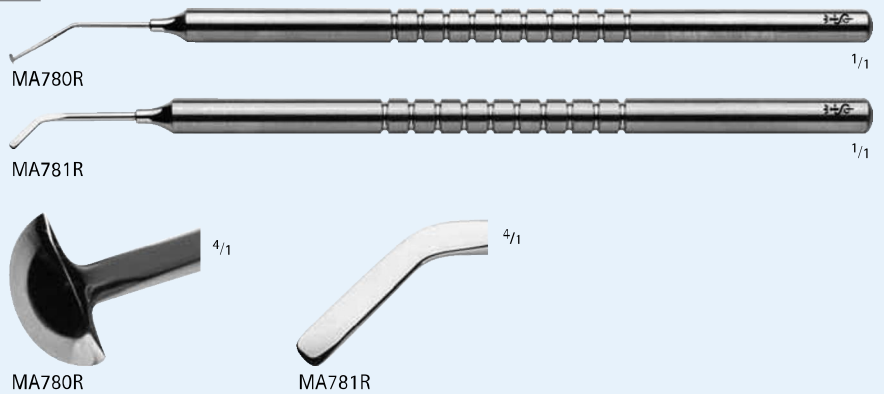

## CHANG-SEIBEL Phaco Chopper

### MA782R

Double Ended, Angled, C-Shaped Blunt Chopper and Vertical Safety Chopper, for Lefthand, 5 1/2"

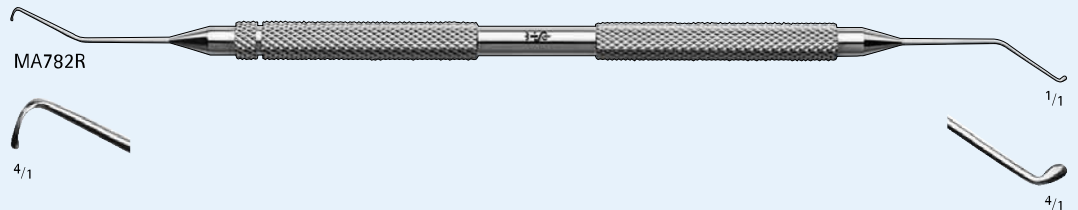

## KOCH Nucleus Spatula

### MA783R

Gently Curved with 1 mm wide Duckbill Tip, Smooth, 4 1/2"

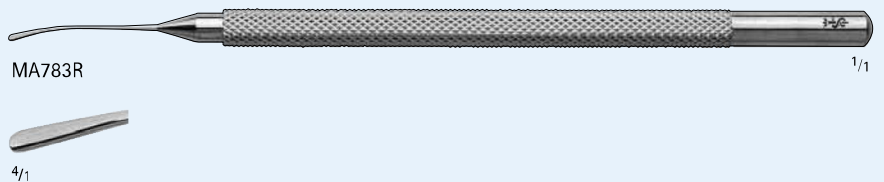

## LIEBERMAN Nucleus Manipulator

### MA784R

Angled, for Lefthand, 4 1/2"

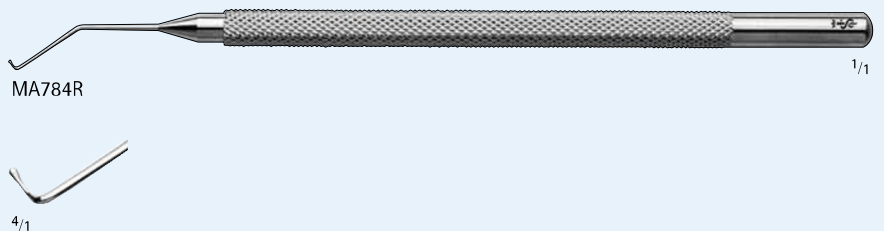

# Ophthalmic Instruments

## Hooks/Manipulators

### CHANG Combo Phaco Chopper

MA785R

Double Ended, Angled, C-Shaped Blunt Chopper and 1.3 mm Sharp "Quick Chop" Tip, for Lefthand, 5 1/4"

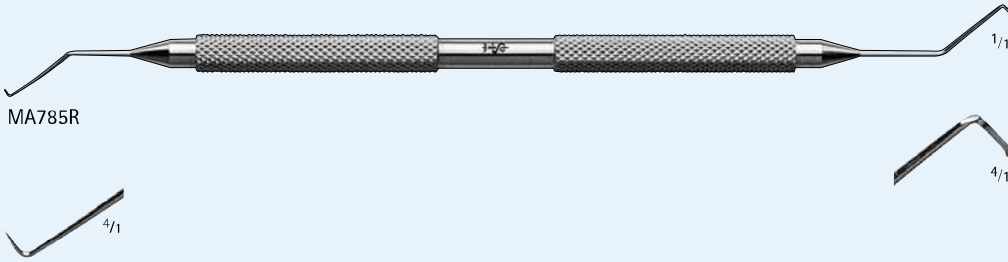

### NAGAHARA Nucleus Spatula

MA786R

Angled, Flat Interior Edge, for Lefthand, 4 1/4"

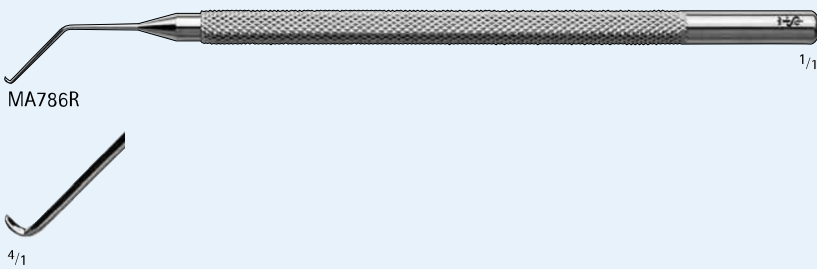

### BECHERT Nucleus Rotator

MA789R

Angled 7 mm from Tip, "Y" Shaped Tip, 4 3/4"

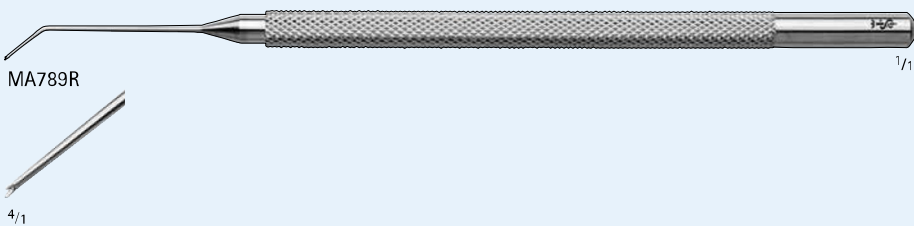

### JAFFE-BECHERT Nucleus Rotator

MA790R

Angled 9 mm from Tip, "Y" Shaped Tip, 4 3/4"

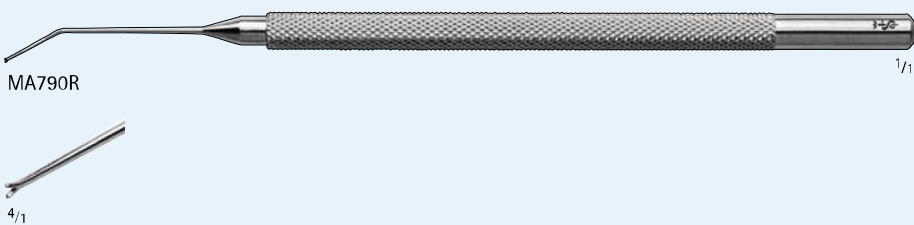

## DRYSDALE Nucleus Manipulator

**MA791R**

Paddle-shaped Tip, 4 1/4"

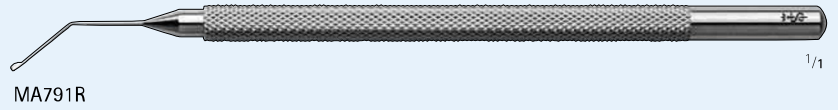

MA791R

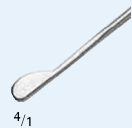

4/1

## PISACANO Nucleus Rotator

**MA792R**

Vertical Flat Tip, 4 1/4"

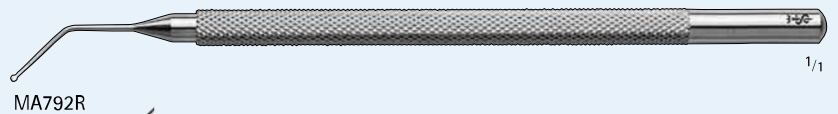

MA792R

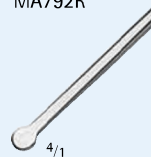

4/1

## ANIS Wand Nucleus Manipulator

**MA793R**

Straight, 0.5 mm Ball-Shaped Tip, 4 3/4"



MA793R

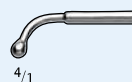

4/1

## SIEBEL Flap Lifter and Spatula

**MA794R**

Double Ended, "Z"-Shaped Tip & 1.5 mm Angled Point, 4 1/8"

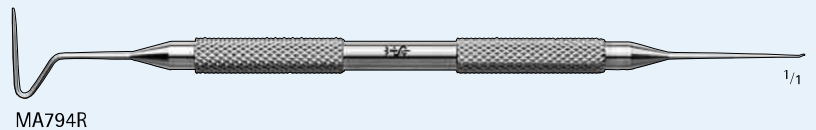

MA794R



2/1



4/1

## JAFFE Lens Spatula

**MA795R**

Flat, 0.5 mm wide Tip, 4 3/4"



MA795R



4/1



# Ophthalmic Instruments

## Hooks/Manipulators

### LESTER IOL Manipulator

**MA776R**

Straight, 0.25 mm Teardrop Shaped Tip, 4½"

**MA796R**

Angled, 0.25 mm Teardrop Shaped Tip, 4½"

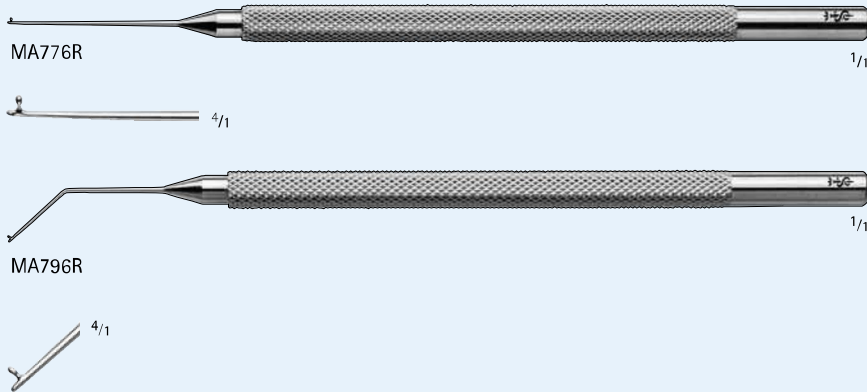

### LESTER II IOL Manipulator

**MA822T**

Angled, 0.2 mm Teardrop Shaped Tip, Titanium, 4½"



### MALONEY IOL Manipulator

**MA797R**

Curved, 0.25 mm Teardrop Shaped Tip, 4½"

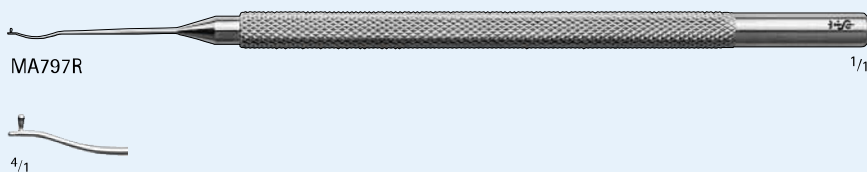



**BARRAQUER Cyclodialysis Spatula**

**MA637R**

0.5 x 15 mm, Angled Blade, 4 7/8"

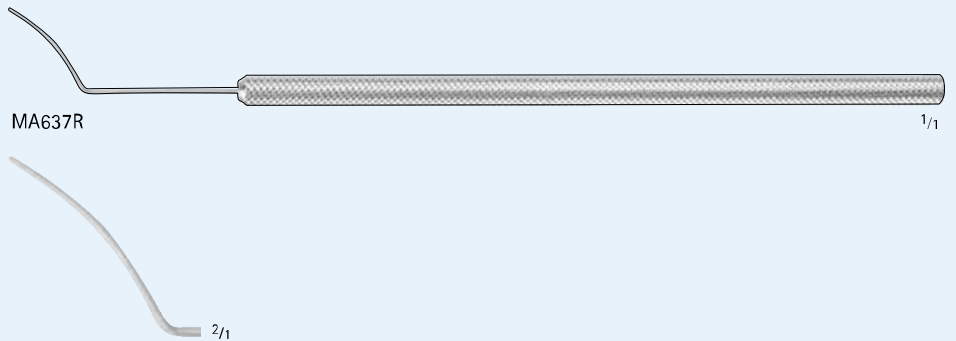

**CASTROVIEJO Cyclodialysis Spatula**

**MA799R**

Double Ended, 10 x 0.5 mm Wide and  
15 x 0.5 mm Wide, 5 1/8"

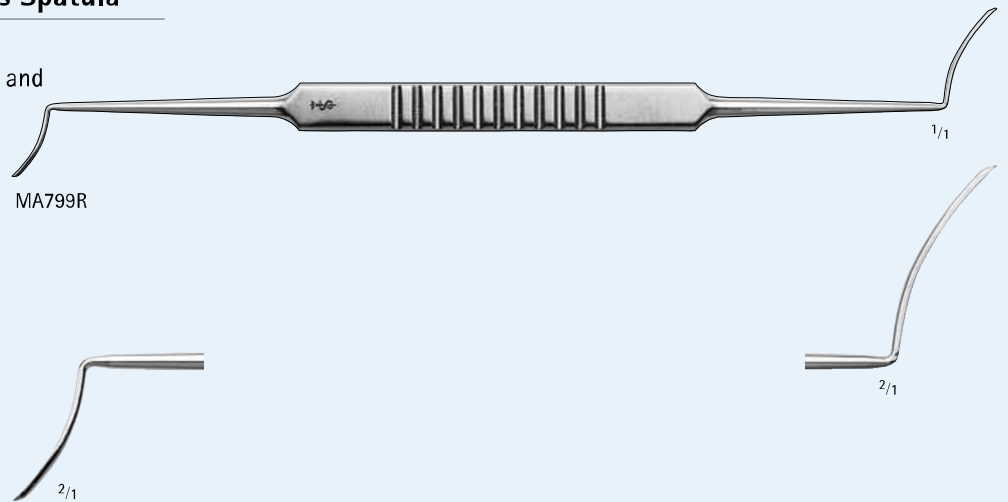

**CASTROVIEJO Synechia Spatula**

**MA798R**

Double Ended, 0.5 mm Wide, 5 1/4"

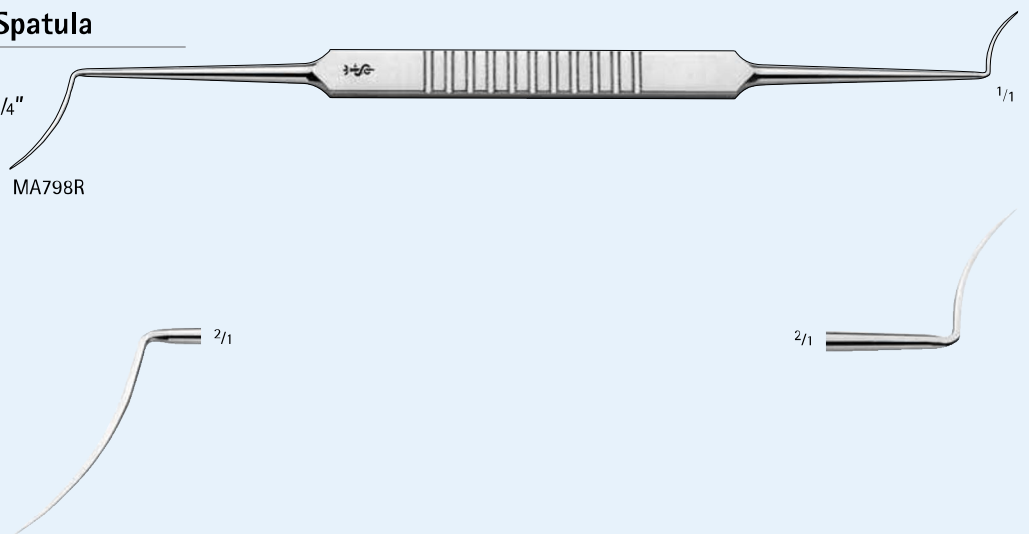

# Ophthalmic Instruments

## Hooks/Manipulators

### PATON Spatula and Spoon

**MA801R**

Double Ended, 6 mm wide Grooved Spoon and 1.5 mm Flat Blade Angled at 8 mm, 5 1/2"

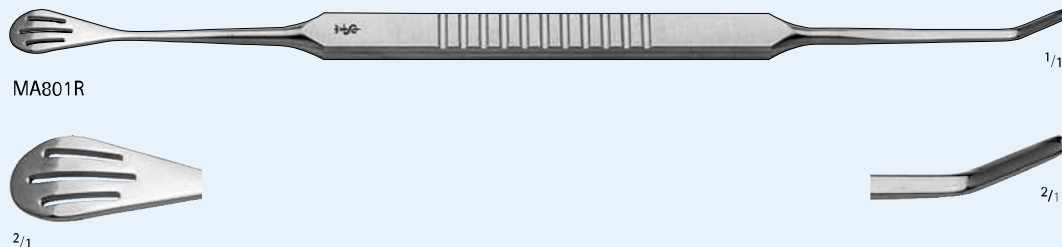

MA801R

2/1

1/1

2/1

### GRAETHER Collar Button

**MA803R**

Angled 45°, 10 mm from Tip, 4 3/4"

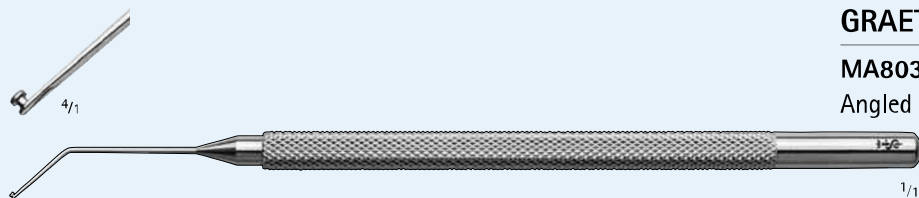

MA803R

4/1

1/1

### CLAYMAN-JAFFE Lens Hook

**MA805R**

Angled, 0.15 mm Blunt Tip, 4 1/2"



MA805R

4/1

1/1

### HARRS-SINSKEY Lens Manipulating Hook

**MA806R**

Angled, 0.25 mm Blunt Tip, Flat Handle, 4 1/2"

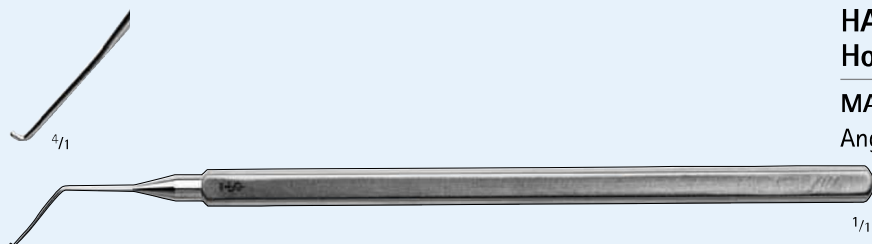

MA806R

4/1

1/1



**SINSKEY Lens Manipulating Hooks**

**MA824R**  
Modified Curved Shaft, Flat Handle, 0.2 mm, 4 1/2"

**MA804R**  
Angled, 0.2 mm Blunt Tip, Reversed, Flat Handle, 4 1/2"

**MA630R**  
Straight, 0.25 mm Hook, Flat Handle, 4 5/8"

**MA807R**  
Straight, 0.25 mm Blunt Tip, Round Handle, 4 1/2"

**MA808R**  
Angled, 0.25 mm Blunt Tip, Round Handle, 4 1/2"



MA824R



MA804R

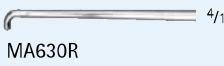

MA630R

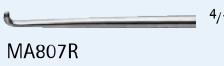

MA807R



MA808R



MA824R

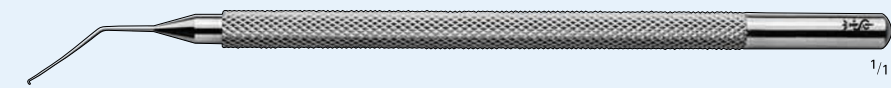

MA804R



MA630R



MA807R

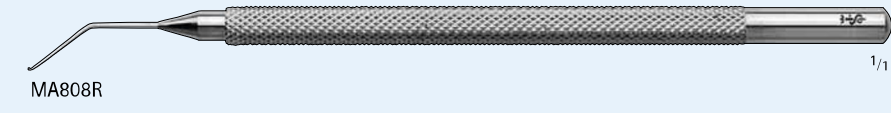

MA808R



# Ophthalmic Instruments

## Hooks/Manipulators

### SINSKEY II Lens Manipulating Hooks

#### MA809R

Straight, 0.2 mm Blunt Tip, Flat Handle, 4 1/2"

#### MA810R

Angled, 0.2 mm Blunt Tip, Flat Handle, 4 1/2"

#### MA811R

Straight, 0.2 mm Blunt Tip, Round Handle, 4 1/2"

#### MA812R

Angled, 0.2 mm Blunt Tip, Round Handle, 4 1/2"

#### MA819T

Angled, 0.2 mm Blunt Tip, Round Handle, Titanium, 4 1/2"

#### MA825T

Straight, 0.2 mm Blunt Tip, Flat Handle, Titanium 4 1/2"



MA809R & MA825T

1/1



MA810R

1/1



MA811R

1/1



MA819T

1/1



MA809R & MA825T

4/1

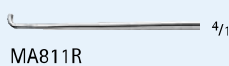

MA811R

4/1



MA810R & MA812R

4/1



MA819T

4/1

## KUGLEN Iris Hook and Lens Manipulators

### MA631R

0.5 mm "K" Hook, Straight Shaft, 4<sup>5</sup>/<sub>8</sub>"

### MA813R

Straight, Push-pull Model, Flat Handle, 4<sup>1</sup>/<sub>2</sub>"

### MA814R

Angled, Push-pull Model, Flat Handle, 4<sup>1</sup>/<sub>2</sub>"

### MA815R

Straight, Push-pull Model, Round Handle, 4<sup>1</sup>/<sub>2</sub>"

### MA816R

Angled, Push-pull Model, Round Handle, 4<sup>1</sup>/<sub>2</sub>"

### MA827T

Straight, "K" Hook Model, Round Handle, Titanium, 4<sup>1</sup>/<sub>2</sub>"

### MA826T

Angled, Push-pull Model, Round Handle, Titanium, 4<sup>1</sup>/<sub>2</sub>"

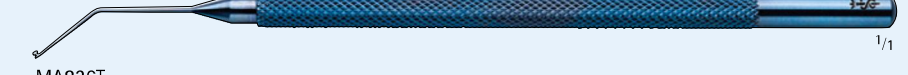
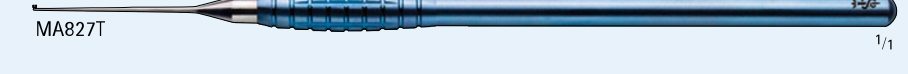
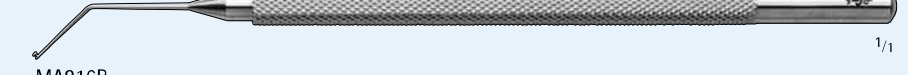
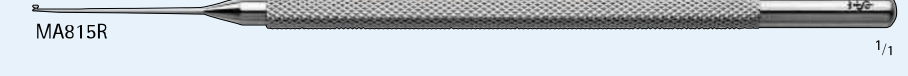
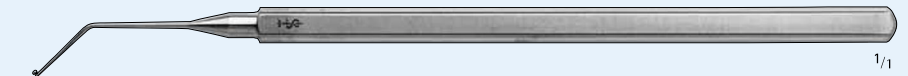
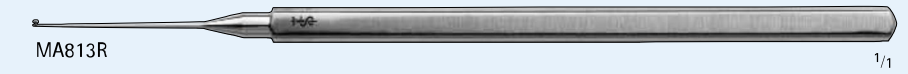
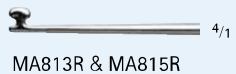
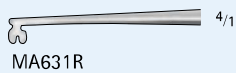

# Ophthalmic Instruments

## Hooks/Manipulators



### OSHER "Y" Hook Lens Manipulator

MA817R

Straight, 4 1/2"

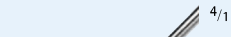
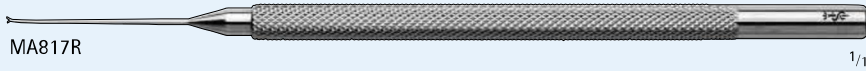

### JAFFE-MALTZMAN Lens Manipulating Hook

MA818R

Angled, 0.15 mm Diameter "V" Shaped Tip, 4 1/2"

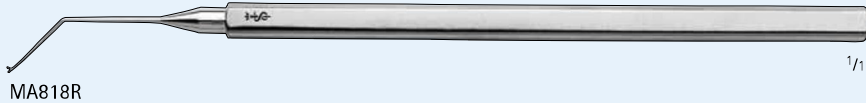

### MCPHERSON Iris Spatula

MA775R

16 x 1 mm, 4 1/2"

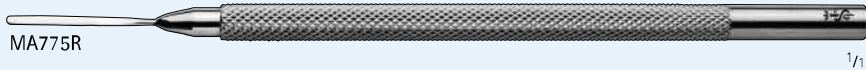

### KIRBY Hook & Muscle Loop

MA820R

Double Ended, 5 x 10 mm, 6 1/8"



### BONN Micro Iris Hook

MA821R

Straight, Blunt, 5"





## JAMESON Muscle Hooks

**MA632R**

Small, 5<sup>3</sup>/<sub>16</sub>"

**MA828R**

Large, 1.7 mm Wide Tip, 10 mm, 4<sup>3</sup>/<sub>4</sub>"

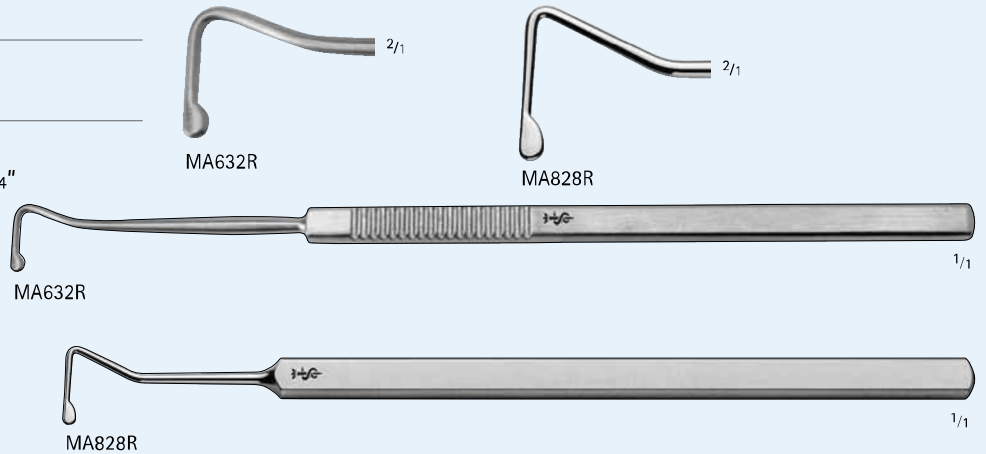

## Green Strabismus Hook

**MA633R**

Flat, 8 mm Wide Hook, 5<sup>1</sup>/<sub>8</sub>"

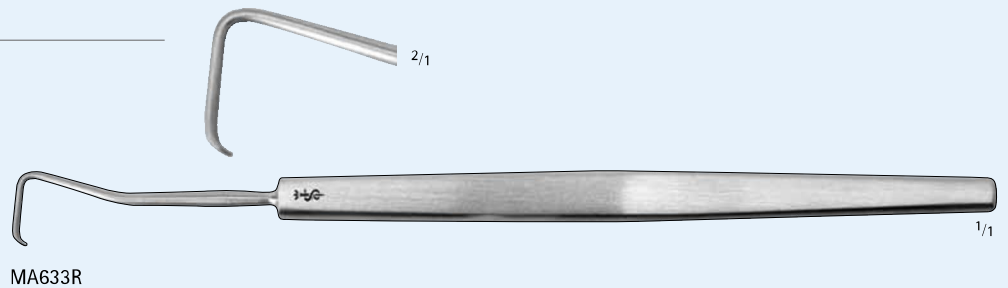

## Twist Fixation Hook

**MA634R**

Right, Clockwise Twist, 4<sup>5</sup>/<sub>16</sub>"



## GASS Retinal Detachment Hook

**MA635R**

5<sup>5</sup>/<sub>8</sub>"

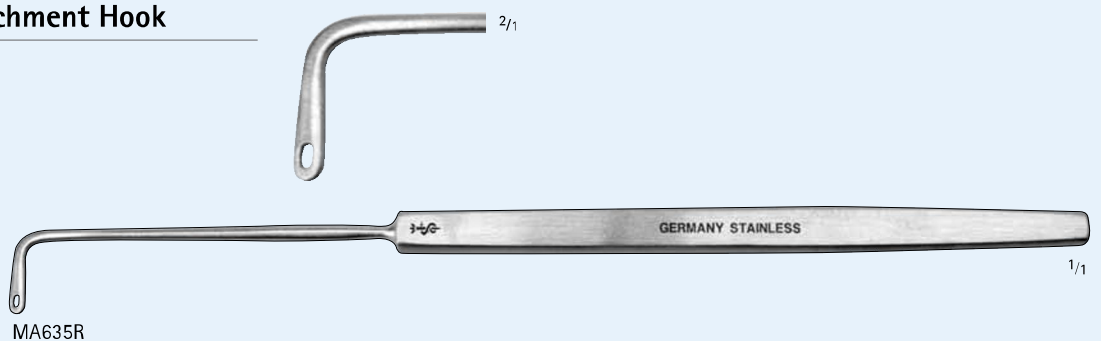

## STEVENS Tenotomy Hook

**MA636R**

5 mm Curved Blunt Hook, 4<sup>5</sup>/<sub>8</sub>"

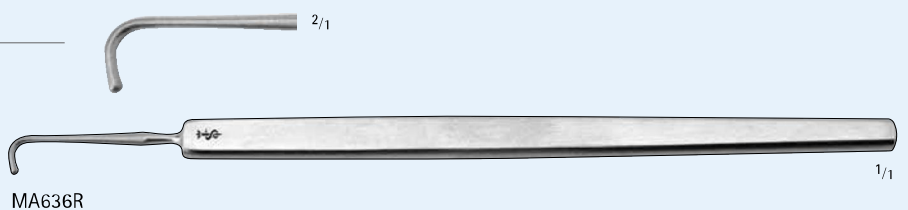

# Ophthalmic Instruments

## Hooks/Manipulators



### ALFONSO Nucleus Trisector

MA800R

1.5 mm Wide, 4 1/8"



MA800R



### PIGTAIL Probes

MA971R

Blunt, 8 mm Diameter Pigtails, 6 1/8"

MA924R

MA924R

Blunt, 8 mm Diameter Pigtails, Suture Holes, 5 1/8"

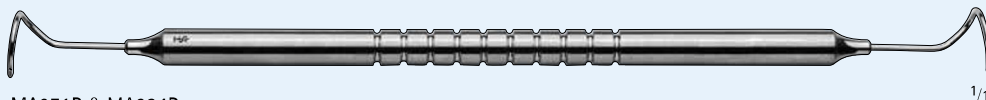

MA971R & MA924R



### NEW ORLEANS Lens Loop

MA823R

4 x 10 mm loop, 5 1/2"



MA823R

# Fixation Rings/Markers



## FLIERINGA Scleral Fixation Rings

**MA732R**

12 mm Diameter

**MA733R**

13 mm Diameter

**MA734R**

14 mm Diameter

**MA735R**

15 mm Diameter

**MA736R**

16 mm Diameter

**MA737R**

17 mm Diameter

**MA738R**

18 mm Diameter

**MA739R**

19 mm Diameter

**MA740R**

20 mm Diameter

**MA741R**

21 mm Diameter

**MA742R**

22 mm Diameter

**MA743R**

Set of 8, 15-22 mm Diameter

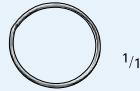

MA732R-MA743R

## OSHER-NEUMANN Corneal Marker

**MA975R**

8 Blade, 4 1/8"



MA975R

1/1

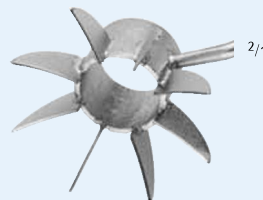

2/1

## THORNTON Swivel Fixation Ring

**MA829R**

13 mm Diameter, Blunt Teeth, 4 1/2"



MA829R

1/1

# Ophthalmic Instruments

## Fixation Rings/Markers

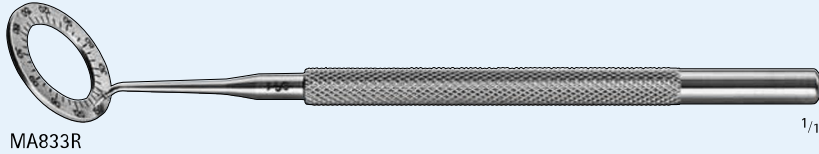

MA833R

1/1

### MENDEZ Degree Gauge

MA833R

12 mm ID, Calibrated 100 from 0-1800, 4 1/4"



MA834R

1/1

### HENDERSON Degree Gauge

MA834R

Beveled Face, Smooth, For Use with MA837R, 4 1/8"

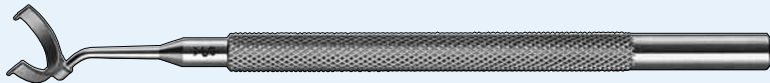

MA835R

1/1

### HENDERSON Alignment Marker

MA835R

Blunt Pin Markings at 3, 6, & 9 O'Clock, For Use with MA834R & MA837R, 4"

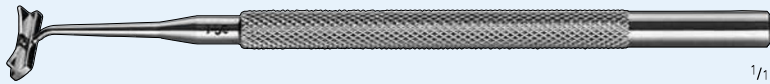

MA836R

1/1

### BORES Axis Marker

MA836R

For Use with MA833R, 4"



MA837R

1/1

### HENDERSON Toric IOL Marker

MA837R

2.5 mm Axis Marks, for use with MA834R, 4"



MA838R - MA841R

1/1

### BORES Optical Zone Markers

MA838R

3.5 mm ID, 4"

MA839R

6.0 mm ID, 4 1/8"

MA840R

7.0 mm ID, 4 1/8"

MA841R

8.0 mm ID, 4 1/8"



MA838R

2/1



MA839R

2/1



MA840R

2/1



## Fixation Rings/Markers

### HOFFER Optical Zone Markers

#### MA842R

4.25 mm ID, 4"

#### MA843R

5.0 mm ID, 4"

#### MA844R

5.5 mm ID, 4"

#### MA845R

6.0 mm ID, 4"

#### MA846R

8.0 mm ID, 4 1/8"



MA844R - MA846R

1/1



MA842R

2/1



MA843R

2/1



MA844R

2/1



MA846R

2/1

## Scissors

### CASTROVIEJO Corneal Section Scissors

#### MA850R

Right, Angled 9 mm Blade, Blunt Tips, 4 1/4"

#### MA851R

Left, Angled 9 mm Blade, Blunt Tips, 4 1/4"

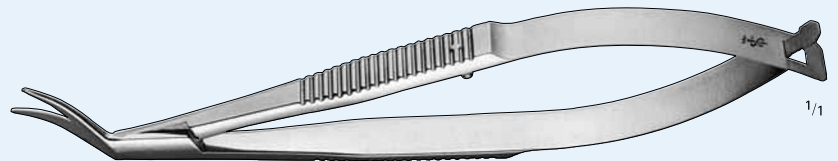

MA850R

1/1



2/1

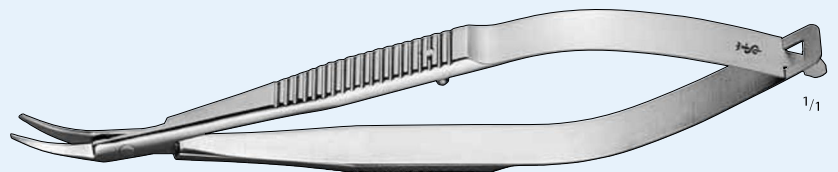

MA851R

1/1



2/1

# Ophthalmic Instruments

## Scissors

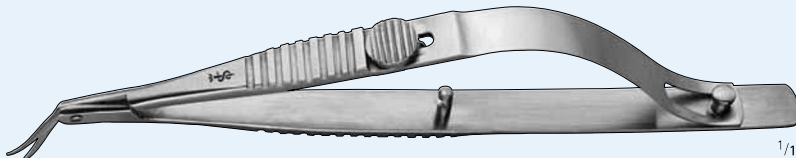

MA847R

### TROUTMAN Corneal Scissors

MA847R

Right, 10 mm Blade, 4 1/8"

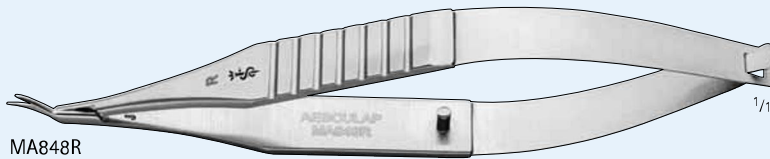

MA848R

### CASTROVIEJO Corneal Scissors

MA848R

Curved Right, Small Blade, 4"

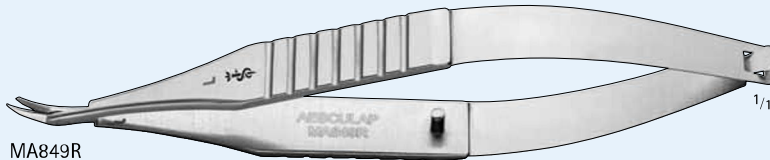

MA849R

MA849R

Curved Left, Small Blade, 4"

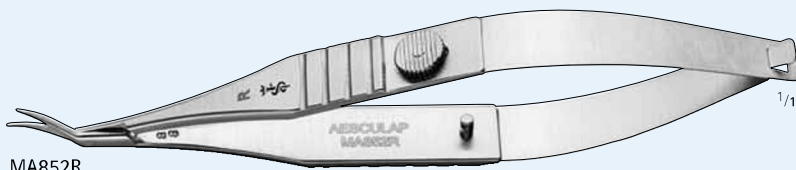

MA852R

### TROUTMAN-CASTROVIEJO Corneal Scissors

MA852R

Curved Right, Medium Blade, Lock, 4 1/8"

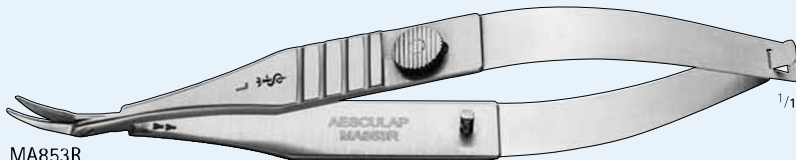

MA853R

MA853R

Curved Left, Medium Blade, Lock, 4 1/8"

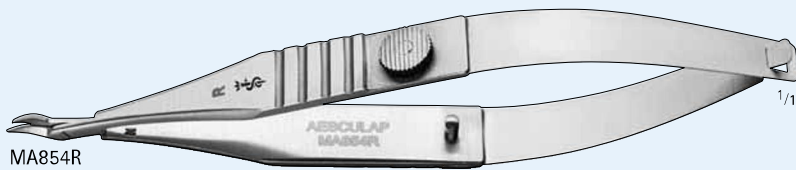

MA854R

### TROUTMAN-KATZIN Corneal Scissors

MA854R

Strong Curved Right, Lock, 4 1/8"

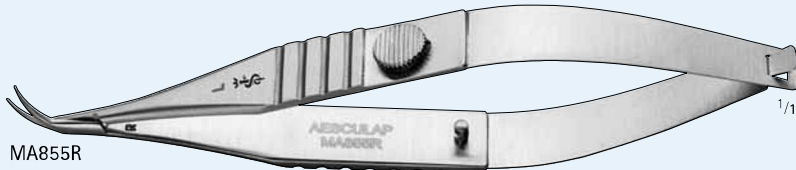

MA855R

MA855R

Strong Curved Left, Lock, 4 1/8"

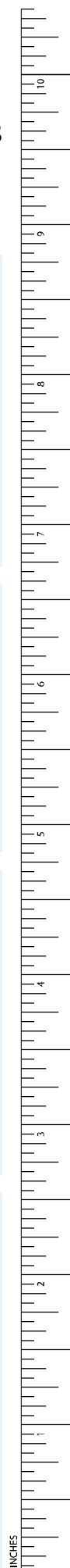

## CASTROVIEJO Universal Corneal Scissors

### MA858R

Curved Blunt Tips, 16 mm from Mid-Screw, 4 3/4"

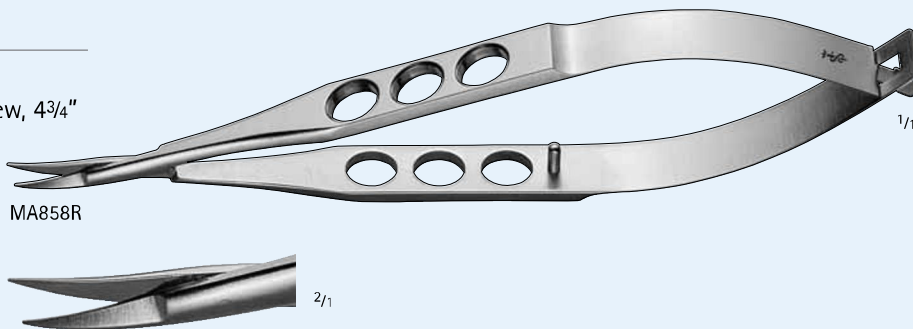

## Micro Iris Scissors

### MA873R

Curved Sharp Tips, 10 mm from Mid-Screw, 4 1/8"

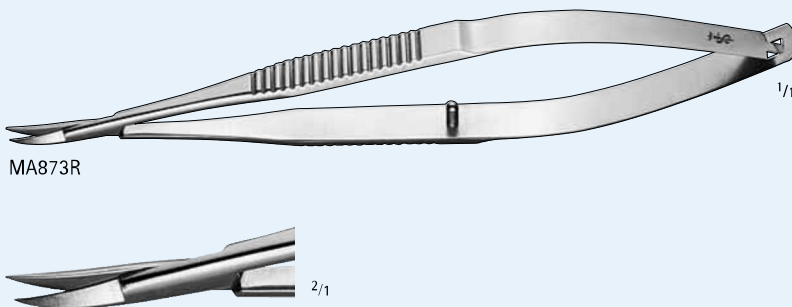

## RICH Corneal Scissors

### MA856R

Strong Curved Right, X-Delicate, 4 1/8"

### MA857R

Strong Curved Left, X-Delicate, 4 1/8"

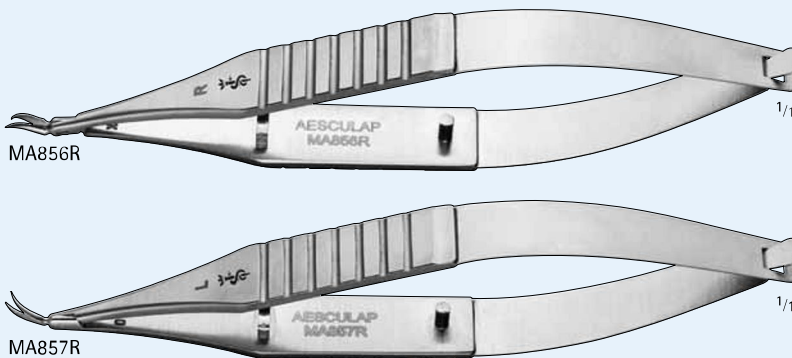

## KATZIN Corneal Transplant Scissors

### MA859R

Strong Curved Right, Medium Blade, 4 1/8"

### MA860R

Strong Curved Left, Medium Blade, 4 1/8"

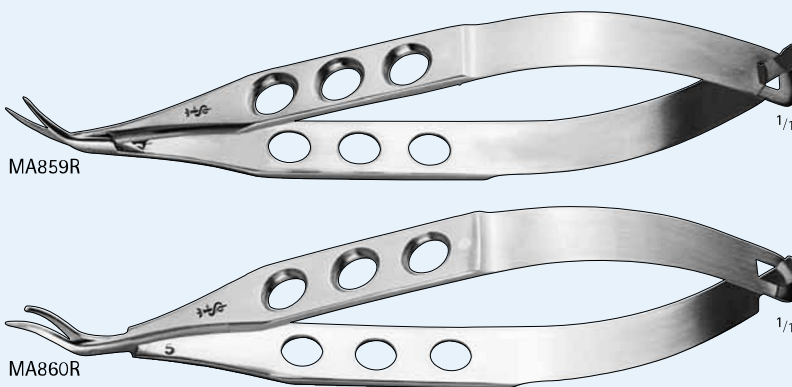

# Ophthalmic Instruments

## Scissors

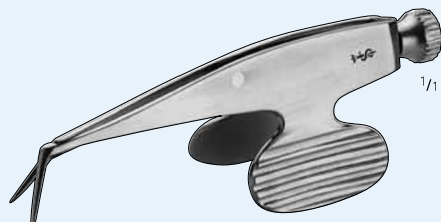

MA861R

### BARRAQUER Iris Scissors

MA861R

Blunt, 8 mm Blade, 2 1/4"

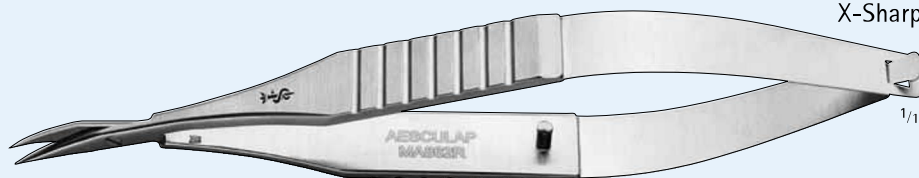

MA862R

### JAFFE Stitch Scissors

MA862R

X-Sharp, Curved, 4 3/4"

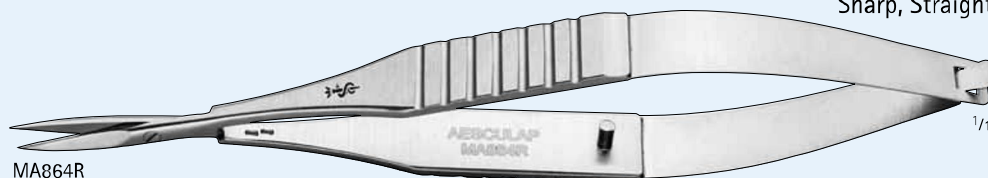

MA864R

### FINE Stitch Scissors

MA864R

Sharp, Straight, 5 1/8"

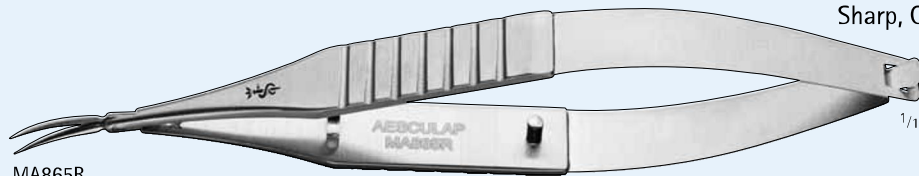

MA865R

### VANNAS Scissors

MA865R

Sharp, Curved, 10 mm Blades, 4 3/4"

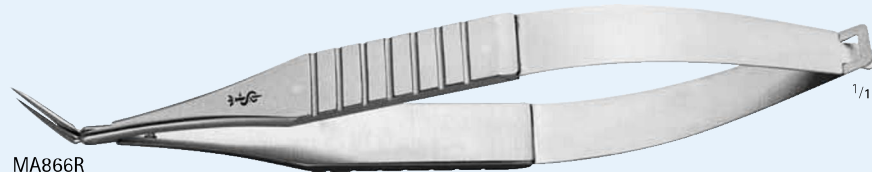

MA866R

### STERN-GILLS Scissors

MA866R

Sharp, X-Delicate, Straight Angled Forward,  
10 mm Blades, 4 1/2"

## URIBE-STERN Scissors

### MA867R

Sharp, X-Delicate, Curved Angled Forward, 10 mm Blades, 4<sup>3</sup>/<sub>4</sub>"

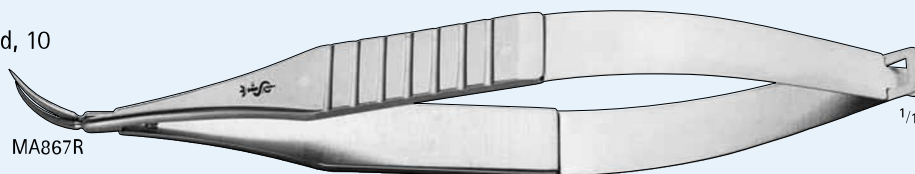

MA867R

## UTHOFF-GILLS Capsulotomy Scissors

### MA868R

Blunt, Angled, Curved Tips, 10 mm, 4<sup>3</sup>/<sub>4</sub>"

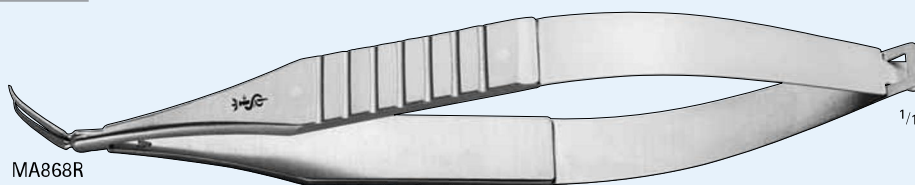

MA868R

## GILLS-WELSH VANNAS Scissors

### MA870R

Sharp, 11 mm Blades, 3<sup>1</sup>/<sub>4</sub>"

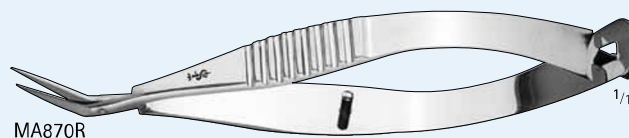

MA870R

## DEWECKER Iris Scissors

### MA612R

Sharp and Blunt Tips, 4<sup>1</sup>/<sub>2</sub>"



MA612R

## VANNAS Capsulotomy Scissors

### MA483R

Straight, 3<sup>1</sup>/<sub>4</sub>"

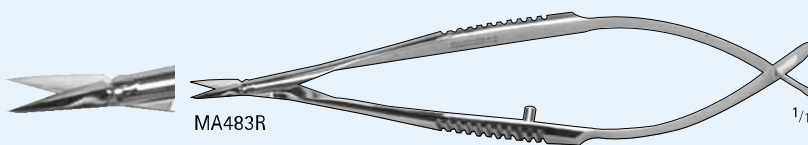

MA483R

### MA484R

Curved, 3<sup>1</sup>/<sub>4</sub>"

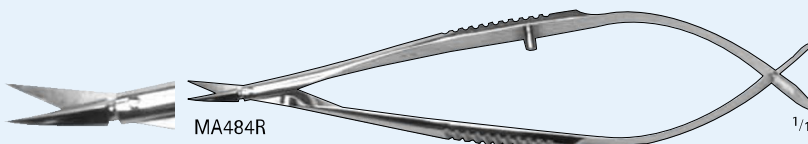

MA484R

### MA485R

Angled Down, 3<sup>1</sup>/<sub>4</sub>"

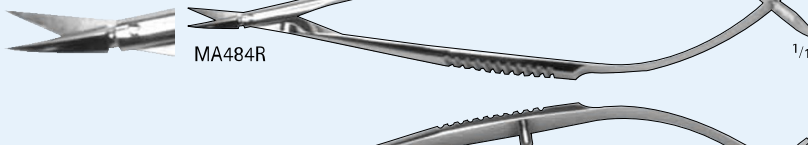

MA485R

### MA486R

Angled Up, 3<sup>1</sup>/<sub>4</sub>"

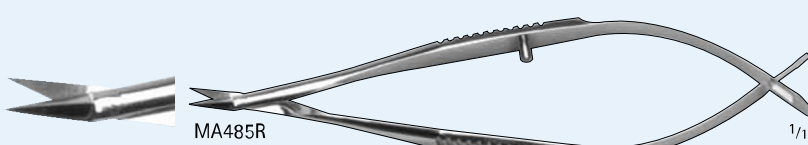

MA486R

# Ophthalmic Instruments

## Scissors



### WESTCOTT Stitch Scissors

**MA487R**  
Sharp Point, 5 1/2"

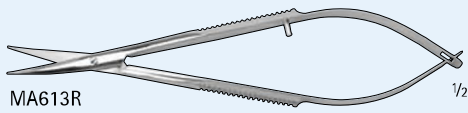

**MA613R**  
Blunt Tips, Right, 4 3/4"

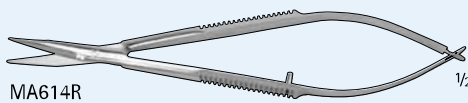

**MA614R**  
Blunt Tips, Left, 4 3/4"

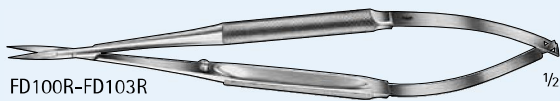

### Micro Scissors

**FD100R**  
Round Handle, Straight, Sharp/Sharp, 5 3/4"

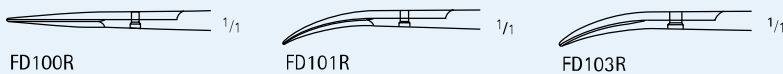

**FD101R**  
Round Handle, Curved, Sharp/Sharp, 5 3/4"



**FD103R**  
Round Handle, Curved, Blunt/Blunt, 5 3/4"



**OC496R**  
Flat Handle, Straight, 4 1/8"

**OC497R**  
Flat Handle, Curved, 4 1/8"

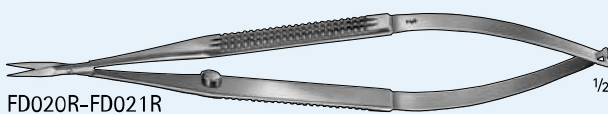

### MILLESI Micro Scissors

**FD020R**  
Flat Handle, Serrated, Straight, 6 1/4"

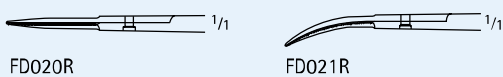

**FD021R**  
Flat Handle, Serrated, Curved, 6 1/4"

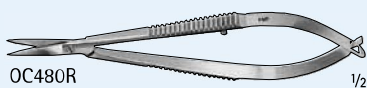

### MCCLURE Micro Scissors

**OC480R**  
Flat Handle, Straight, 3 3/4"



### NOYES Micro Scissors

**OC482R**  
Flat Handle, Straight, 5"

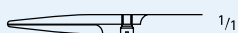

# Scissors



## CASTROVIEJO Scissors

**OC485R**

Flat Handle, Lat-Angled, 3<sup>3</sup>/<sub>4</sub>"

**OC486R**

Flat Handle, Lat-Curved, 3<sup>3</sup>/<sub>4</sub>"

**OC491R**

Flat Handle, Left-Curved, 4<sup>3</sup>/<sub>8</sub>"

**OC492R**

Flat Handle, Right-Curved, 4<sup>3</sup>/<sub>8</sub>"

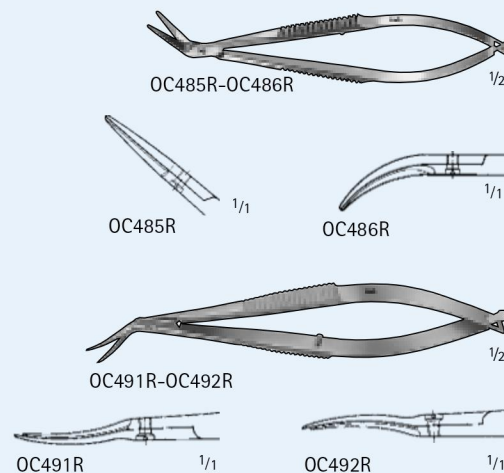

## VANNAS Micro Scissors

**OC498R**

Flat Handle, Straight, 3<sup>3</sup>/<sub>8</sub>"

**OC499R**

Flat Handle, Curved, 3<sup>3</sup>/<sub>8</sub>"

**OC500R**

Flat Handle, Angled, 3<sup>3</sup>/<sub>8</sub>"

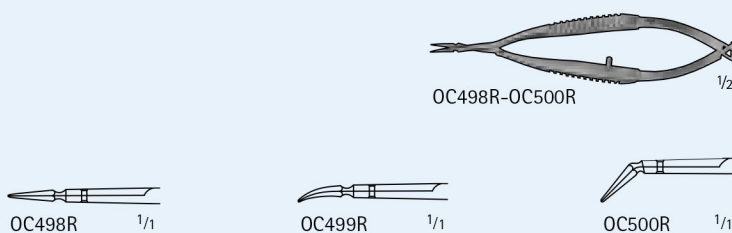

## Iris Scissors

**BC004R**

Square Handle, Straight, Sharp/Sharp, 4<sup>1</sup>/<sub>2</sub>"

**BC005R**

Square Handle, Curved, Sharp/Sharp, 4<sup>1</sup>/<sub>2</sub>"

**BC050R**

Delicate, Round Handle, Straight, Sharp/Sharp, 4<sup>3</sup>/<sub>8</sub>"

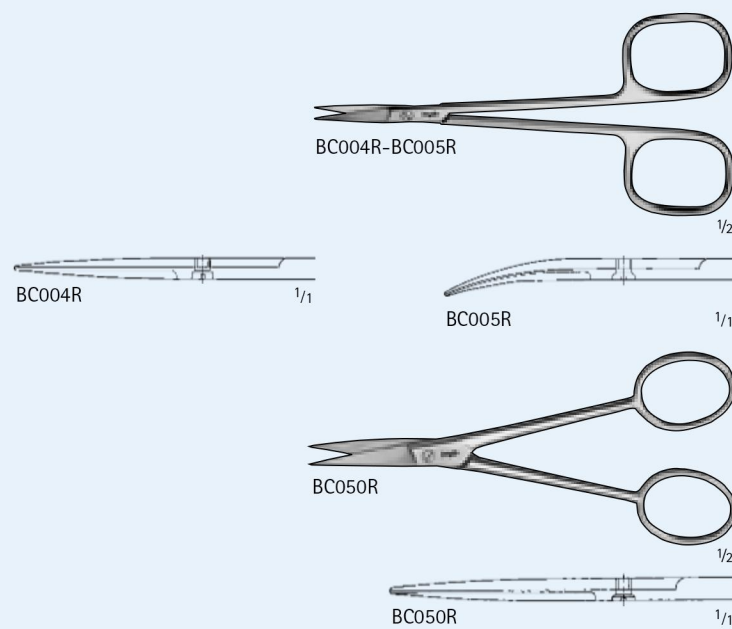

# Ophthalmic Instruments

## Scissors

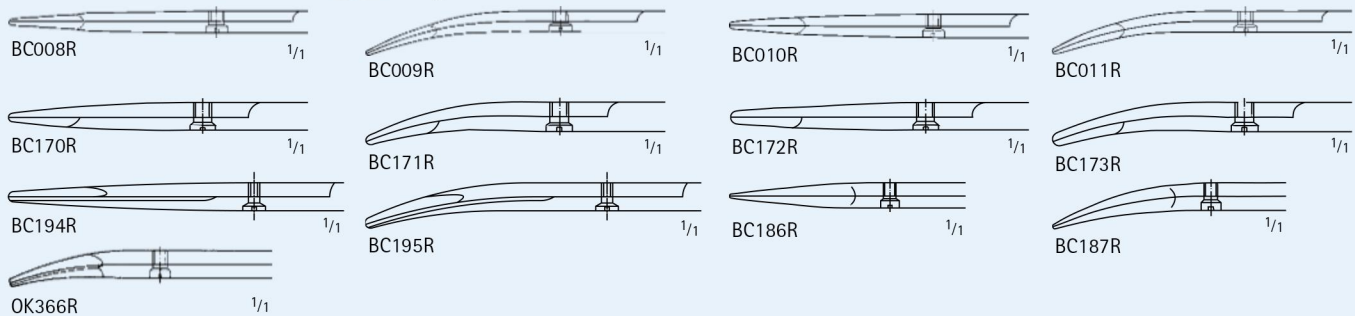
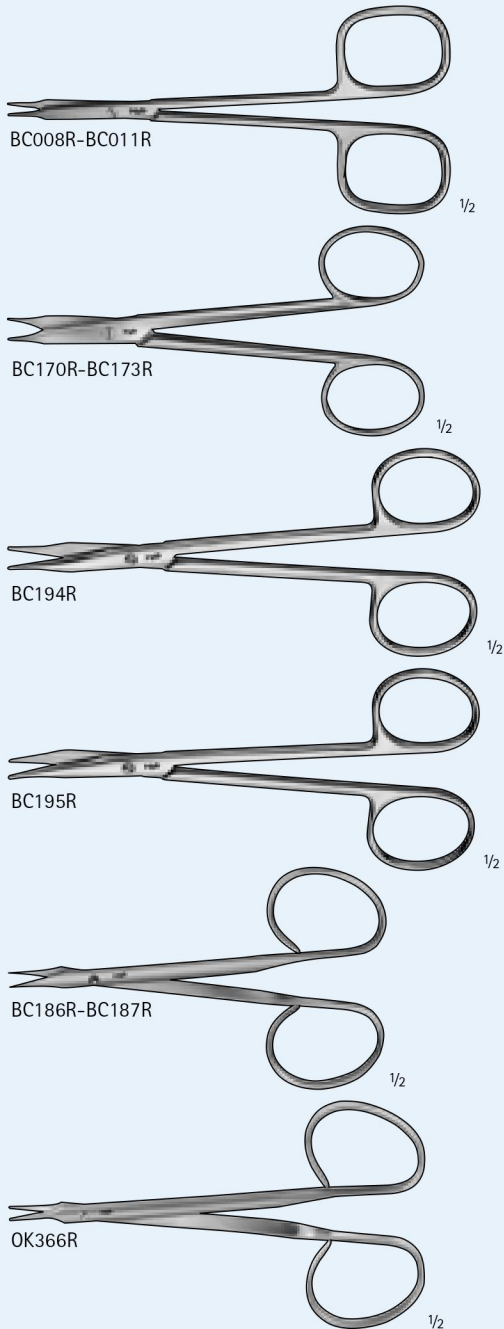

### STEVENS Tenotomy Scissors

#### BC008R

Square Handle, Straight, Sharp/Sharp, 4 1/2"

#### BC009R

Square Handle, Curved, Sharp/Sharp, 4 1/2"

#### BC1010R

Square Handle, Straight, Blunt/Blunt, 4 1/2"

#### BC011R

Square Handle, Curved, Blunt/Blunt, 4 1/2"

#### BC170R

Round Handle, Straight, Sharp/Sharp, 4 3/8"

#### BC171R

Round Handle, Curved, Sharp/Sharp, 4 3/8"

#### BC172R

Round Handle, Straight, Blunt/Blunt, 4 3/8"

#### BC173R

Round Handle, Curved, Blunt/Blunt, 4 3/8"

#### BC194R

Fine, Round Handle, Straight, Blunt/Blunt, 5"

#### BC195R

Fine, Round Handle, Curved, Blunt/Blunt, 5"

#### BC186R

Ribbon Handle, Straight, Sharp/Sharp, 4"

#### BC187R

Ribbon Handle, Curved, Sharp/Sharp, 4"

#### OK366R

Ribbon Handle, Curved, Blunt/Blunt, 4 3/8"

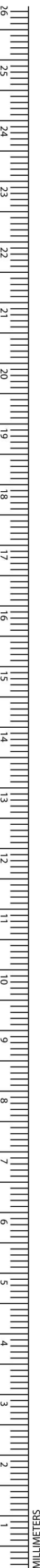





## Strabismus Scissors

### BC020R

Delicate, Square Handle, Straight, Blunt/Blunt, 4 1/2"

### BC021R

Delicate, Square Handle, Curved, Blunt/Blunt, 4 1/2"

### BC164R

Delicate, Round Handle, Straight, Blunt/Blunt, 4 1/2"

### BC165R

Delicate, Round Handle, Curved, Blunt/Blunt, 4 1/2"

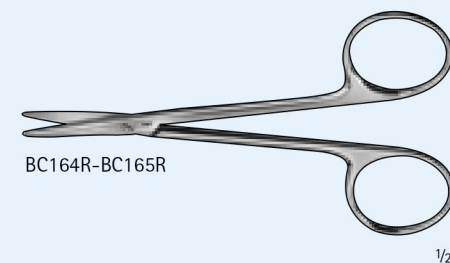
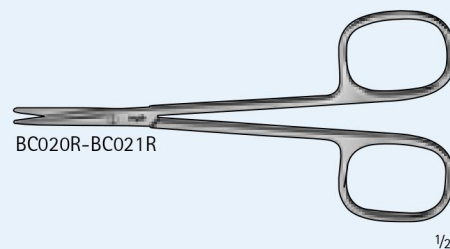

## Iris Scissors, Durotip

### BC210R

TC, Straight, Sharp/Sharp, 4 3/8"

### BC211R

TC, Curved, Sharp/Sharp, 4 3/8"

### BC211W

TC, Serrated, Curved, Sharp/Sharp, 4 3/8"

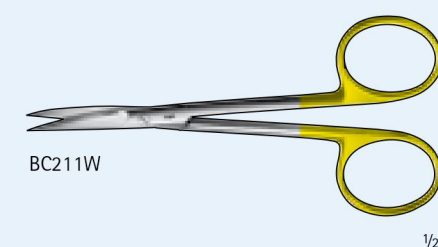
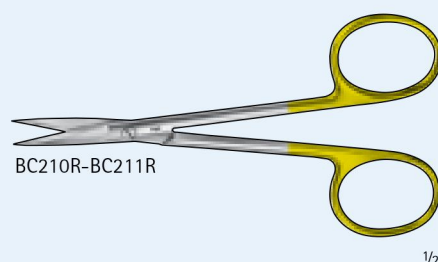
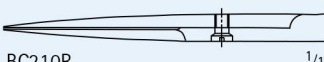

## Strabismus Scissors, Durotip

### BC256R

TC, Straight, Blunt/Blunt, 4 1/2"

### BC257R

TC, Curved, Blunt/Blunt, 4 1/2"

### BC257W

TC, Serrated, Curved, Blunt/Blunt, 4 1/2"

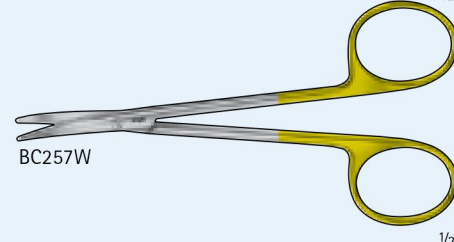
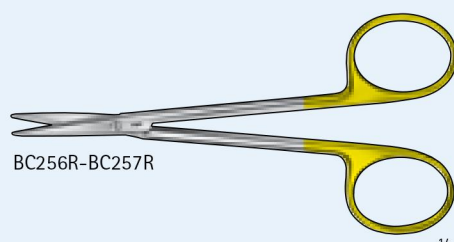
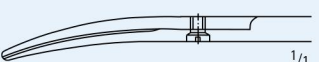
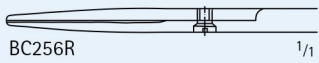

# Ophthalmic Instruments

## Scissors

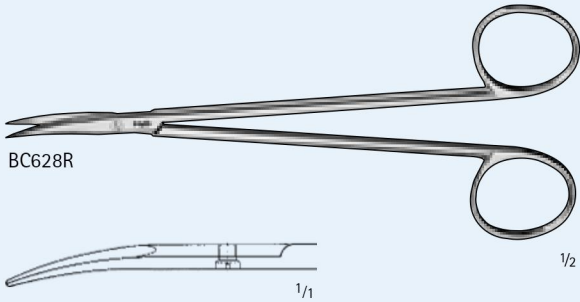

### Nerve Scissors

**BC628R**

Curved, Sharp/Sharp, 6"

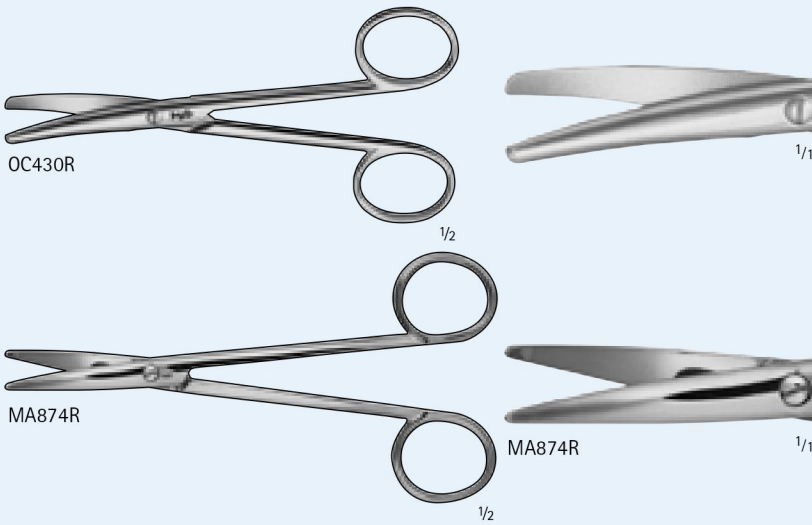

### Enucleation Scissors

**OC430R**

Curved, 5"

**MA874R**

Full Curved, Heavy, 5 1/8"

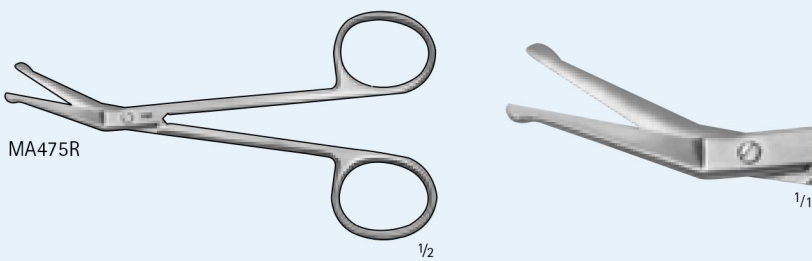

### Eye Scissors

**MA475R**

Blunt Probe Tips, Angled, 4 1/2"

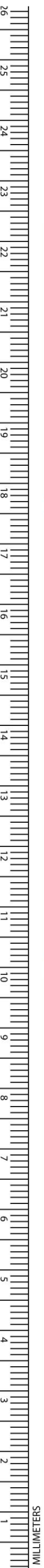

## Utility Scissors

### MA476R

Ribbon Handle, Straight, Blunt, 4"

### MA477R

Ribbon Handle, Curved, Blunt, 4"

### MA478R

Ribbon Handle, Curved, Flat, 3<sup>7</sup>/<sub>8</sub>"

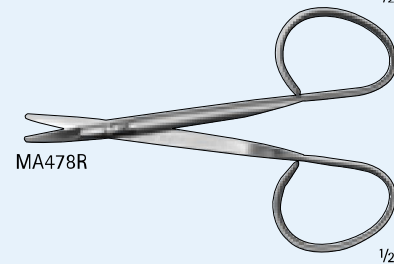
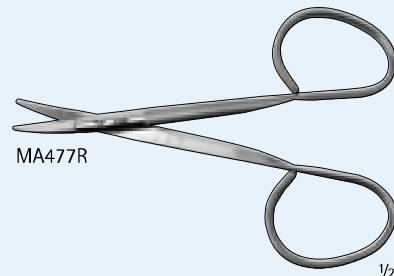
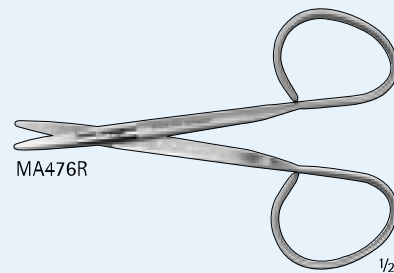

## Stitch Scissors

### MA479R

Ribbon Handle, Curved, Flat, 3<sup>3</sup>/<sub>4</sub>"

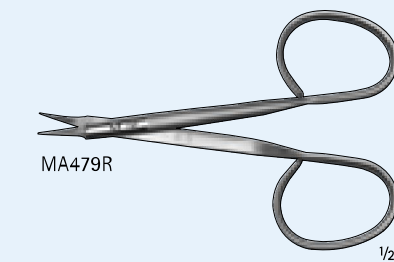

## Stitch Removal Scissors

### MA480R

4<sup>3</sup>/<sub>4</sub>"

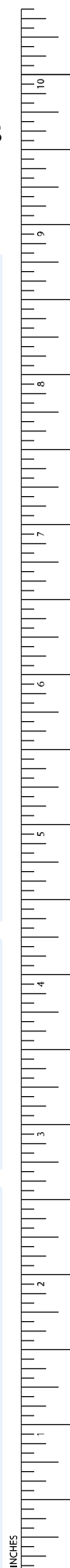
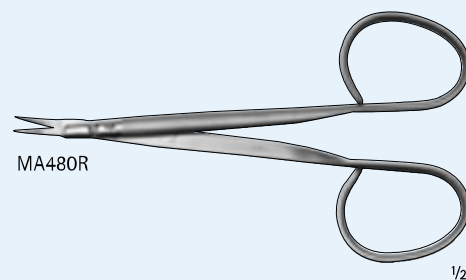

# Ophthalmic Instruments

## Scissors

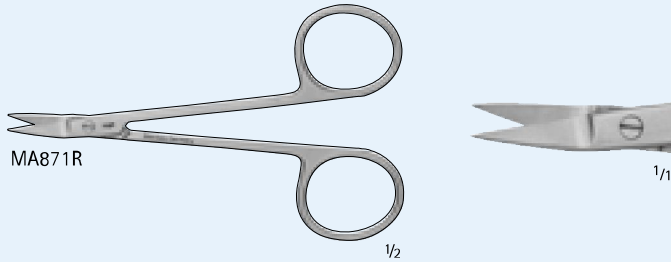

### WILMER Conjunctival Scissors

MA871R

Angled-Flat, 17 mm, 4 1/8"

## Forceps

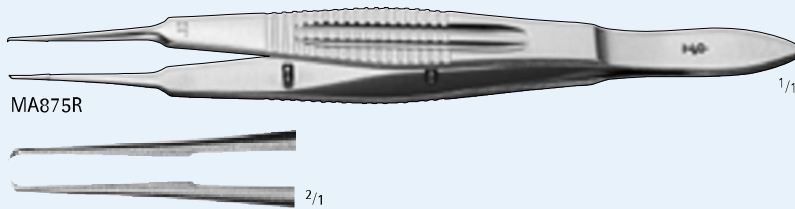

### OSHER-ELSCHNIG Forceps

MA875R

1 x 2 Teeth, 3 mm x 0.12 Tying Platform, 4 1/8"

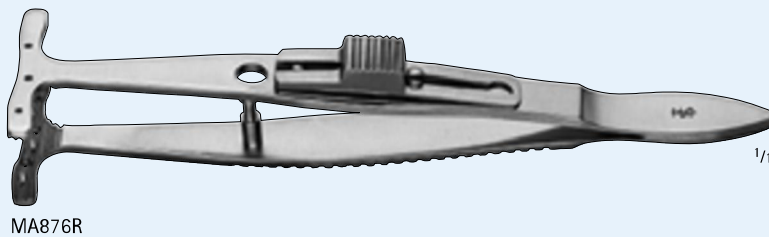

### PUTTERMAN-Type Muscle Forceps

MA876R

Serrated, 6 Pins, Lock, 4"

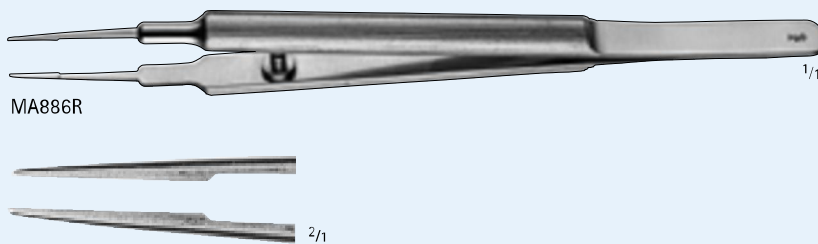

### TENNANT Tying Forceps

MA886R

Straight, Extra Delicate, Smooth Jaws, 6 mm Platform, 4 1/4"



### AKAHOSHI Combo Prechopper

MA888R

Straight, 4.5 mm Tips, Cross-Action, 4 1/4"



**SINSKEY Tying Forceps**

**MA885R**

X-Delicate, Smooth, Curved, 4"

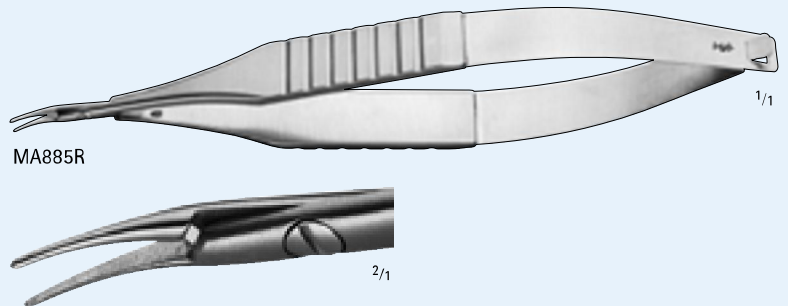

**SHEPARD Lens Holding Forceps**

**MA891R**

Curved, Duckbill Jaws, X-Action, 5"

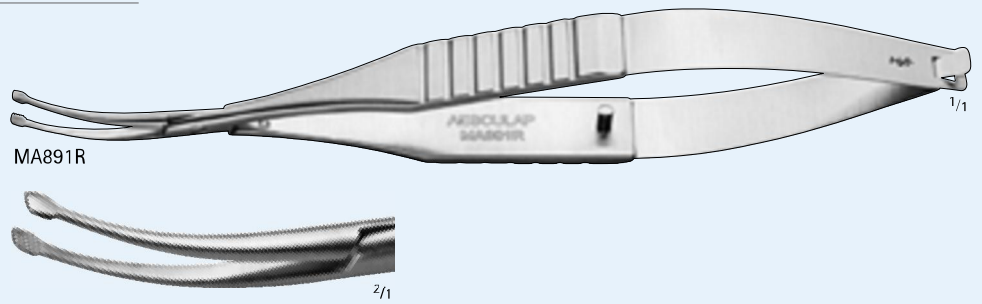

**CLAYMAN Lens Holding Forceps**

**MA892R**

Curved, Delicate Angled Jaws, X-Action, 4 3/4"

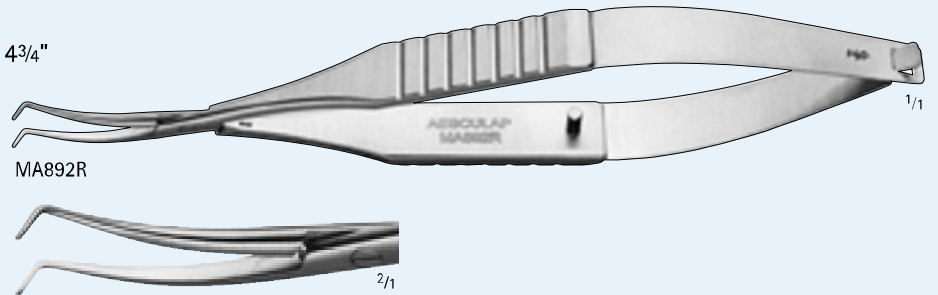

**SCLERAL Plug Forceps**

**MA896R**

Curved Angled, 9 mm Jaws, X-Action, 4 1/8"

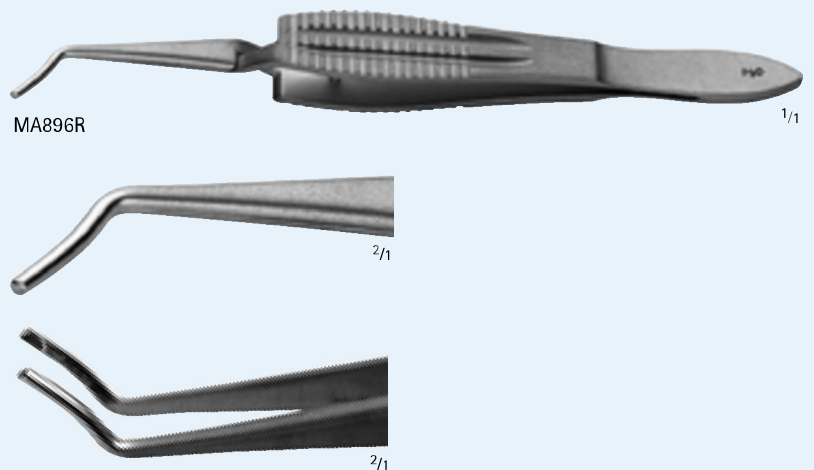

# Ophthalmic Instruments

## Forceps



MA898T

### DEVGAN Capsulorhexis Forceps

**MA898T**

X-Delicate, Semi-sharp tips, 5"



MA148R - MA149R

1/2



MA150R

1/2



MA151R

1/2



MA152R

1/2



MA153R

1/2



MA154R

1/2



MA158R

1/2



MB477R

1/2



MA148R - MA149R

1/1



MA150R

1/1



MA151R

1/1



MA152R

1/1

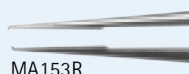

MA153R

1/1



MA154R

1/1



MA158R

1/1

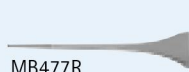

MB477R

1/1

### CASTROVIEJO Suture Forceps

**MA148R**

0.5 mm, 1 x 2 Teeth, with Tying Platform, Wide Handle, 4 1/4"

**MA149R**

1.5 mm, 1 x 2 Teeth, with Tying Platform, 4 1/4"

**MA150R**

0.5 mm, 1 x 2 Teeth, with Tying Platform, 4 1/4"

**MA151R**

0.9 mm, 1 x 2 Teeth, with Tying Platform, 4 1/4"

**MA152R**

0.22 mm, 1 x 2 Teeth, with Tying Platform, 4 1/4"

**MA153R**

0.12 mm, 1 x 2 Teeth, with Tying Platform, 4 3/8"

**MA154R**

0.5 mm, Angled 45° 1 x 2 Teeth, with Tying Platform, 4 1/4"

**MA158R**

0.3 mm Tip, 1 x 2 Teeth, with Tying Platform, 4 1/8"

**MB477R**

0.3 mm, 1 x 2 Teeth, with Tying Platform, Wide Handle, 4 3/8"



OC094R

1/2

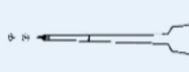

1/1

### CASTROVIEJO Tissue Forceps

**OC094R**

Delicate, 1 x 2 Teeth 0.5 mm, 4"



MA618R

1/2



1/1

### CASTROVIEJO Cross Action

**MA618R**

10 mm from Angle to Tip, 4 1/8"

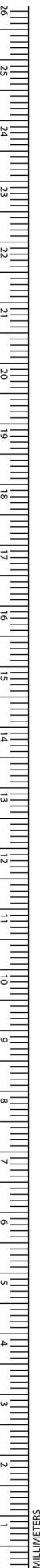

# Forceps

## BONN Suture Forceps

**MA155R**

0.12 mm, 1 x 2 Teeth, Platform, 3<sup>3</sup>/<sub>4</sub>"

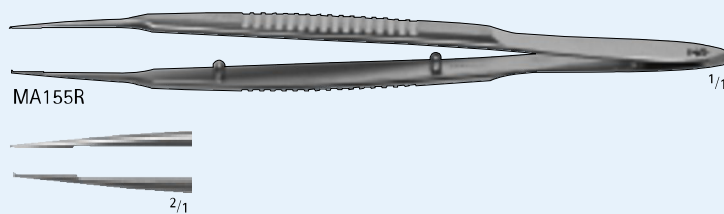

## BONN Tissue Forceps

**MA878R**

1 x 2 Teeth, 0.12 mm, 3"

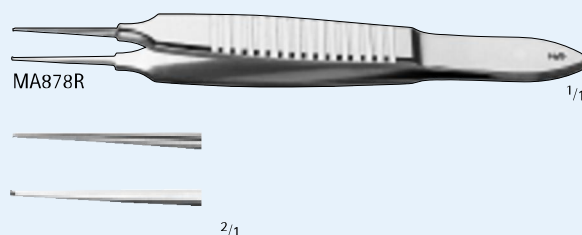

## THORPE Conjunctival Fixation Forceps

**MA157R**

2 x 3 Teeth, 3<sup>3</sup>/<sub>4</sub>"

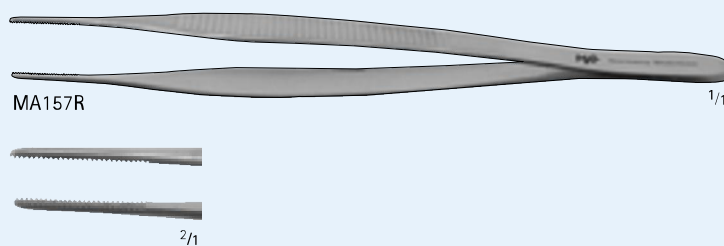

## THORPE Corneal Forceps

**MA901R**

Straight, 45°, 0.12 mm, 2 x 3 Teeth, 3<sup>3</sup>/<sub>4</sub>"

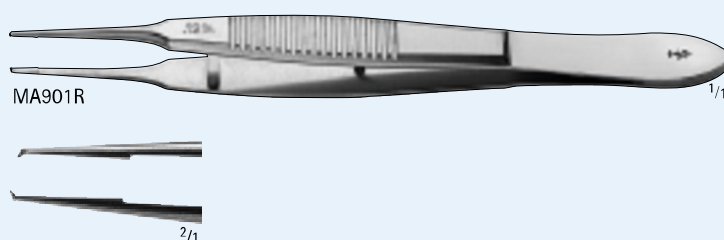

## LESTER Fixation Forceps

**MA166R**

Fine 1 x 2 Teeth, 3<sup>3</sup>/<sub>4</sub>"

**MA167R**

Fine 2 x 3 Teeth, 3<sup>3</sup>/<sub>4</sub>"

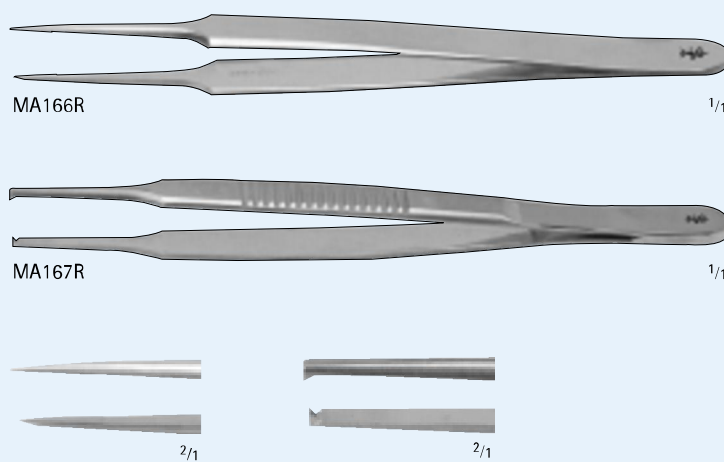





# Forceps

## BERKE Ptosis Forceps

MA316R

20 mm Jaw, 4"

MA317R

27 mm Jaw, 4 1/8"



MA316R



MA317R

## Serrefine

MA548R

10 mm Serrated Jaws, 1 3/8"



MA548R

## LEHNER-UTRATA Capsulotomy Forceps

MA881R

Curved, 12 mm Angled Tips, Flat Handle, 3 1/2"



MA881R



## UTRATA Capsulorhexis Forceps

MA617R

12 mm Angled Tips, 3 1/8"

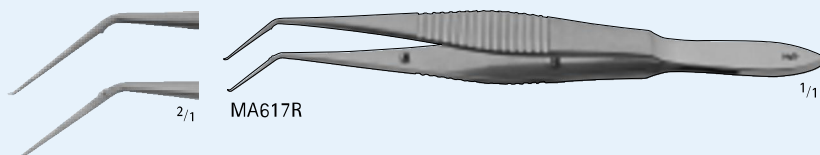

2/1

MA617R

## CORNEAL COLIBRI Style Forceps

MA619R

1 x 2 Teeth, 50° with 6 mm Tying Platform, 4 3/16"

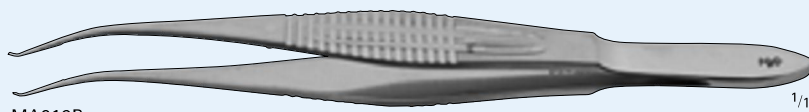

MA619R



## TROUTMAN BARRAQUER Corneal Forceps

MA620R

0.12 mm, 1 x 2 Teeth, 2 7/8"

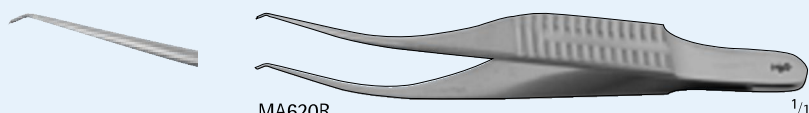

MA620R



INCHES

# Ophthalmic Instruments

## Forceps



MA897T

1/1



2/1

### COLIBRI Forceps

MA897T

0.12 mm, 1x2 Teeth, Titanium, 3"



MA621R

1/1



2/1

### MCPHERSON Angled Corneal Suturing Forceps

MA621R

1 x 2 Teeth, Angled, 45° with 5 mm Tying Platform, 3<sup>3</sup>/<sub>8</sub>"



MA622R

1/1



2/1

### BRACKEN Curved Iris Forceps

MA622R

Curved, Cross Serrated Tips, 3<sup>7</sup>/<sub>8</sub>"



MA624R

1/1



2/1

### KELMAN-MCPHERSON Forceps

MA624R

Angled 45°, 8.5 mm Tying Platform, 3<sup>1</sup>/<sub>4</sub>"



MA625R

1/1



2/1

### MCPHERSON Forceps

MA625R

Straight 5 mm Tying Platform, 3<sup>1</sup>/<sub>4</sub>"



## BECHERT-MCPHERSON Forceps

**MA879R**

Angled, 10 mm tips, 3 1/4"

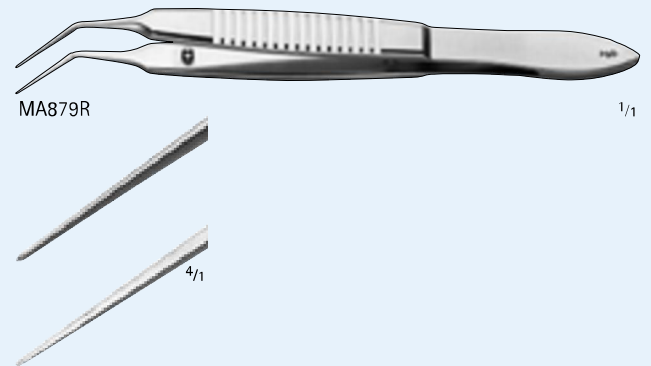

## SHEETS-MCPHERSON Forceps

**MA880R**

Angled, 10 mm, 1 mm Cross-serrated Tips, 3 1/4"

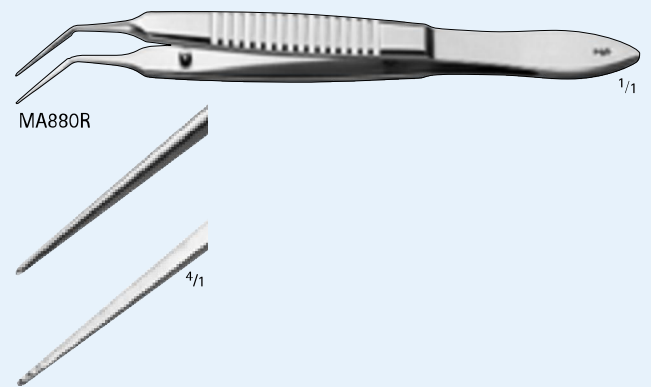

## JAMESON Muscle Forceps

**MA626R**

Left, 12 mm Angled Jaws, 3 3/8"

**MA726R**

Right, 12 mm, Angled Jaws, 4"

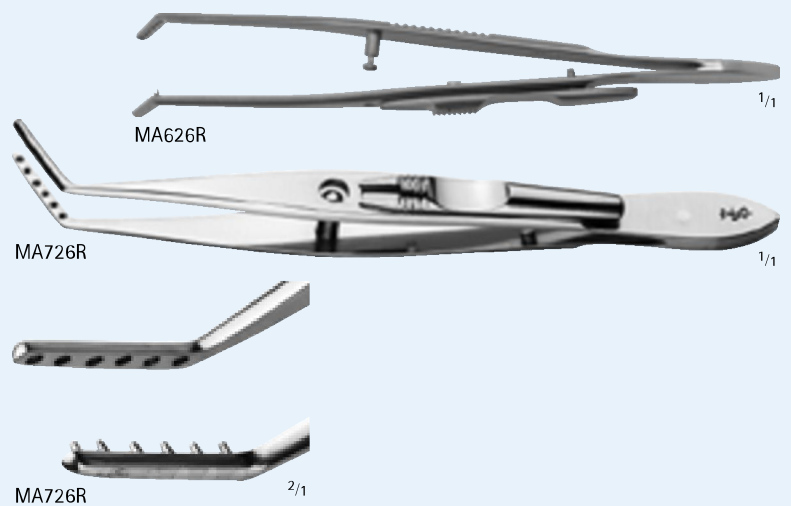

## MCCULLOUGH Utility Forceps

**MA623R**

Smooth Jaw, Straight, 15 mm, 3 5/8"

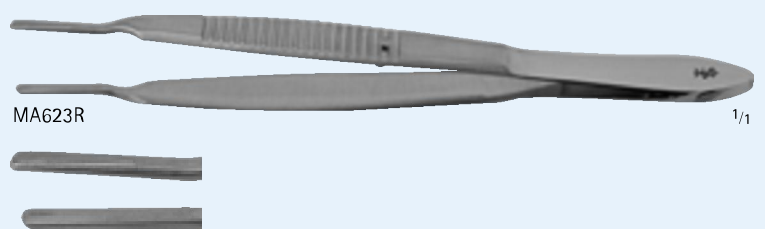

# Ophthalmic Instruments

## Forceps



### BISHOP HARMON Iris Forceps

**MD580**

Without Teeth, Serrated, 3 1/2"



**OC051R**

1 x 2 Teeth, 3 1/2"



### Iris Forceps

**OC020R**

Delicate, Serrated, Straight, 4"



**OC021R**

Delicate, Serrated, Curved, 4"

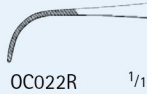

**OC022R**

Delicate, Serrated, Heavy Curved, 4"

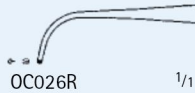
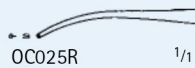
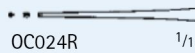

**OC024R**

X-Fine, 1 x 2 Teeth, Straight, 4"

**OC025R**

X-Fine, 1 x 2 Teeth, Curved, 4"

**OC026R**

X-Fine, 1 x 2 Teeth, Heavy Curved, 4"

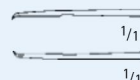

### ST MARTIN Tissue Forceps

**OC091R**

Delicate, 1 x 2 Teeth, 3 1/8"

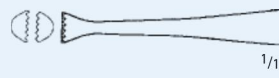

### GRAEFE Tissue Forceps

**OC100R**

4 1/2"

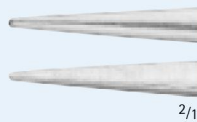

### Tying Forceps

**MA899R**

Straight, 4 1/4"



### ALABAMA UNIVERSITY Forceps

**MA900R**

Straight, 15 mm V-Grooved Platform, 3 1/2"



### TROUTMAN Superior Rectus Forceps

**MA902R**

1 x 2 Teeth, 10 mm, Angled, 4 1/8"

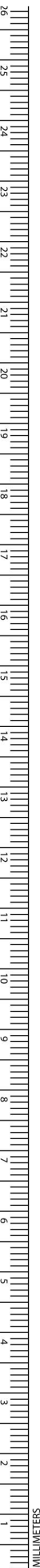

# Needle Holders



## BARRAQUER Micro Needle Holder

### BM560R

Round Handle, Curved, Smooth, without Catch, 4 1/2"



BM560R 1/1

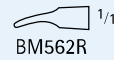

BM562R 1/1



BM560R-BM562R 1/2

### BM562R

Round Handle, Curved, Delicate Smooth, without Catch, 4 3/4"



FD230R 1/1

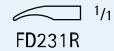

FD231R 1/1



FD230R-FD231R 1/2

### FD230R

Round Handle, Straight, Smooth, without Catch, 4 3/4"

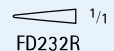

FD232R 1/1

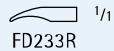

FD233R 1/1

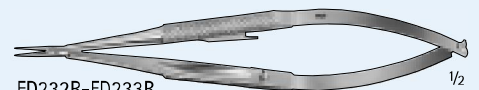

FD232R-FD233R 1/2

### FD232R

Round Handle, Straight, Smooth, with Catch, 4 3/4"



MA351R 1/1

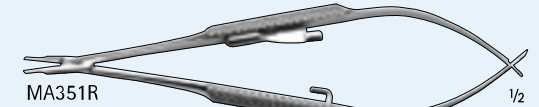

MA351R 1/2

### FD231R

Round Handle, Curved, Smooth, without Catch, 4 3/4"

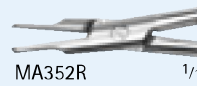

MA352R 1/1

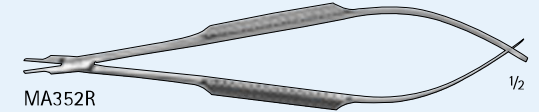

MA352R 1/2

### FD233R

Round Handle, Curved, Smooth, with Catch, 4 3/4"

### MA351R

Round Knurled Handle, Straight, with Catch, 5 1/4"

### MA352R

Round Knurled Handle, Straight, without Catch, 5 1/4"

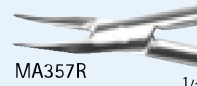

MA357R 1/1



MA357R 1/2

### MA357R

Round Knurled Handle, Curved, without Catch, 5 3/8"

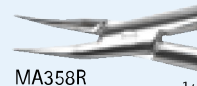

MA358R 1/1

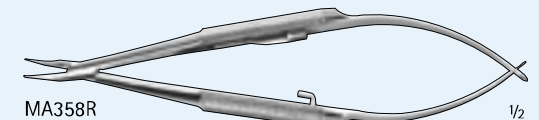

MA358R 1/2

### MA358R

Round Knurled Handle, Curved, with Catch, 5 1/4"

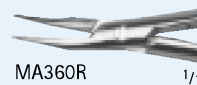

MA360R 1/1



MA360R 1/2

### MA360R

Round Knurled Handle, Curved, without Catch, 4 1/4"

## COHEN Micro Needle Holder

### MA353R

Round Knurled Handle, Curved, without Catch, 4 1/8"



MA353R 1/1

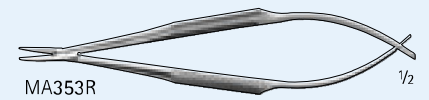

MA353R 1/2

### MA354R

Round Knurled Handle, Curved, with Catch, 4 1/8"



MA354R 1/1

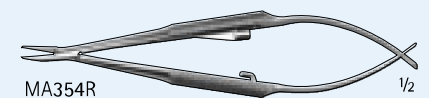

MA354R 1/2

# Ophthalmic Instruments

## Needle Holders

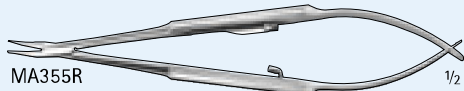

### TROUTMAN Micro Needle Holder

#### MA355R

Flat Handle, Curved, with Catch, 4 3/4"

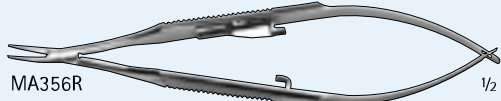

#### MA356R

Flat Handle, Curved, 9 mm Jaw, with Catch, 5 1/8"

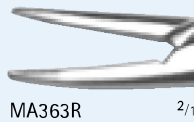
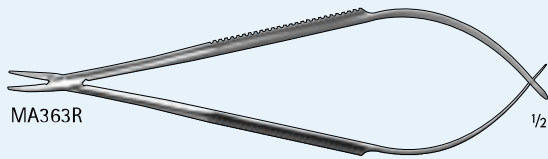

### CASTROVIEJO Micro Needle Holder

#### MA363R

Flat Handle, Curved, 10 mm Jaw, without Catch, 5 5/8"

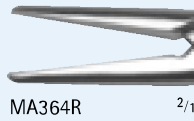
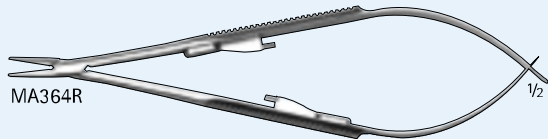

#### MA364R

Flat Handle, Straight, 10 mm Jaw, with Catch, 5 5/8"

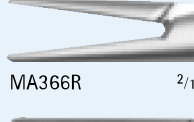
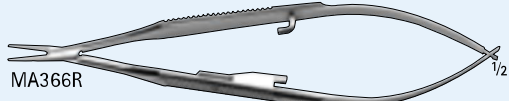

#### MA366R

Flat Handle, Straight, 9 mm Jaw, with Catch, 5 1/8"

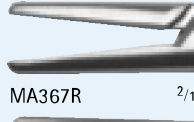

#### MA367R

Flat Handle, Straight, 10 mm Jaw, without Catch, 5 3/8"

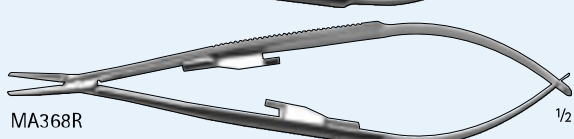

#### MA368R

Flat Handle, Straight, 16 mm Jaw, with Catch, 5 7/8"

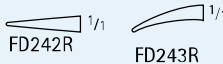
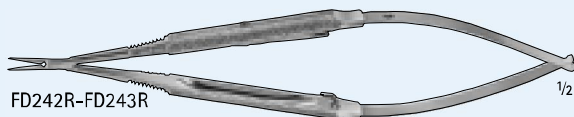

### Micro Needle Holder

#### FD242R

Round Handle, Straight, Smooth, with Catch, 6"

#### FD243R

Round Handle, Curved, Smooth, with Catch, 6"

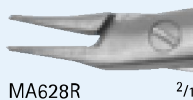

#### MA628R

Delicate Jaws Curved without Lock, Knurled Handle, 4 3/4"

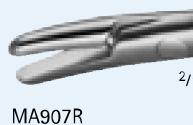
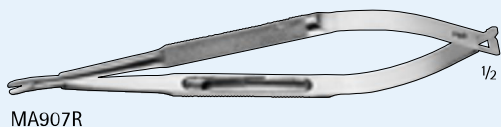

### HAMPTON Micro Needle Holder

#### MA907R

Heavy Jaw, Curved, with Catch, 5 1/8"

## Needle Holders

### MCPHERSON Micro Needle Holder

#### MA908R

Flat Handle, Delicate, Straight, with Catch, 4¼"

#### MA909R

Flat Handle, Delicate, Straight, without Catch, 4¼"

#### MA910R

Flat Handle, Delicate, Curved, with Catch, 4⅞"

#### MA911R

Flat Handle, Delicate, Curved, without catch, 4⅞"

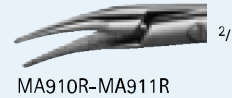
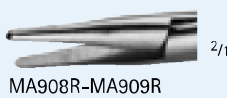
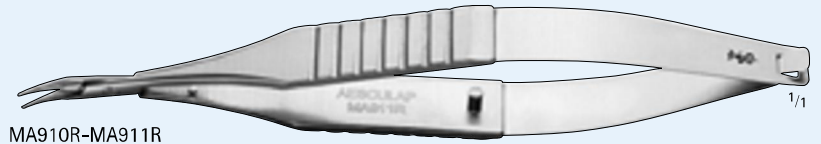
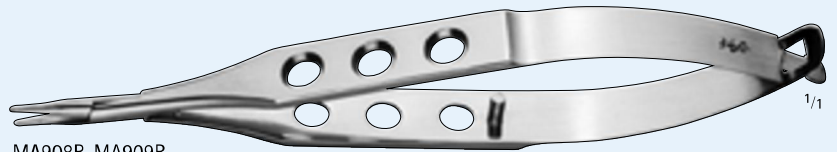

### BROWN Needle Holder

#### MA362R

Serrated, 13 mm Jam, 5¼"

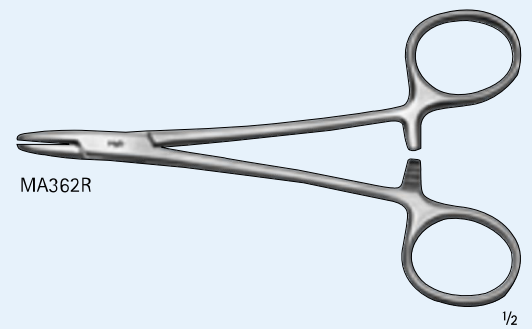
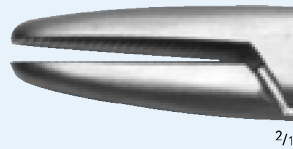

## Dilator/Lacrimal Probes

### CASTROVIEJO Lacrimal Dilator

#### MA921R

Double Ended, Fine and Medium Taper, 4¾"



### RUEDEMANN Lacrimal Dilator

#### MA917R

12 mm, 2¾"



# Ophthalmic Instruments

## Dilator/Lacrimal Probes

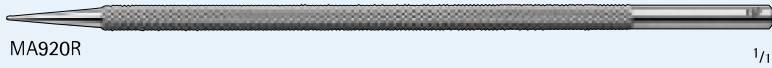

### WILDER Lacrimal Dilators

**MA918R**  
Long Taper , 23 mm, 4"

**MA919R**  
Medium Taper , 18 mm, 4"

**MA920R**  
Short Taper , 13 mm, 4"



### WILLIAMS Lacrimal Probes

**MA410R**  
#00/0, 5 1/2"

**MA411R**  
#1/2, 5 1/2"

**MA412R**  
#3/4, 5 1/2"

**MA413R**  
#5/6, 5 1/2"

**MA414R**  
#7/8, 5 1/2"



### BOWMAN Lacrimal Probes

**MA407R**  
#0000/000, 5 5/8"

**OB510**  
00/0, 5 1/8"

**OB511**  
1/2, 5 1/8"

**OB512**  
3/4, 5 1/8"

**OB513**  
5/6, 5 1/8"

**OB514**  
7/8, 5 1/8"



# Cannulas

## CATALANO Lacrimal Intubation Set

### MA915R

Two 0.7 mm Probes Attached to 250 mm Long  
Silicone Tubing (Single-Use)

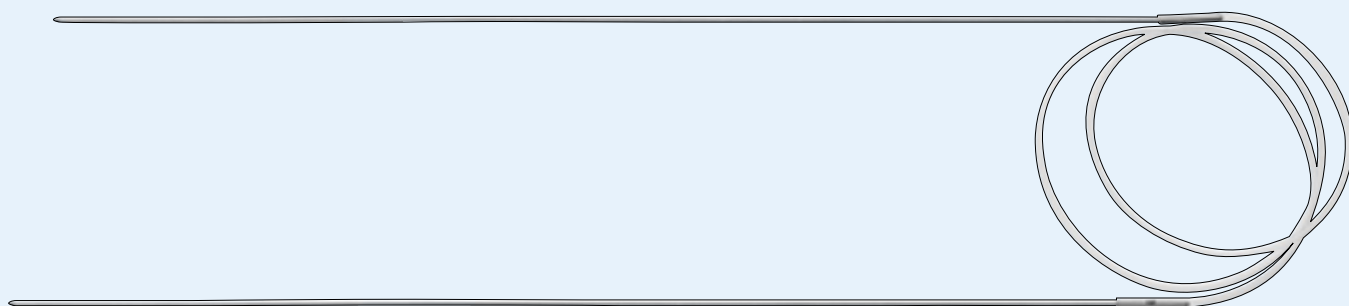

MA915R

## JACKSON Lacrimal Intubation Set

### MA916R

Two 0.9 mm Probes Attached to 250 mm Long  
Silicone Tubing (Single-Use)

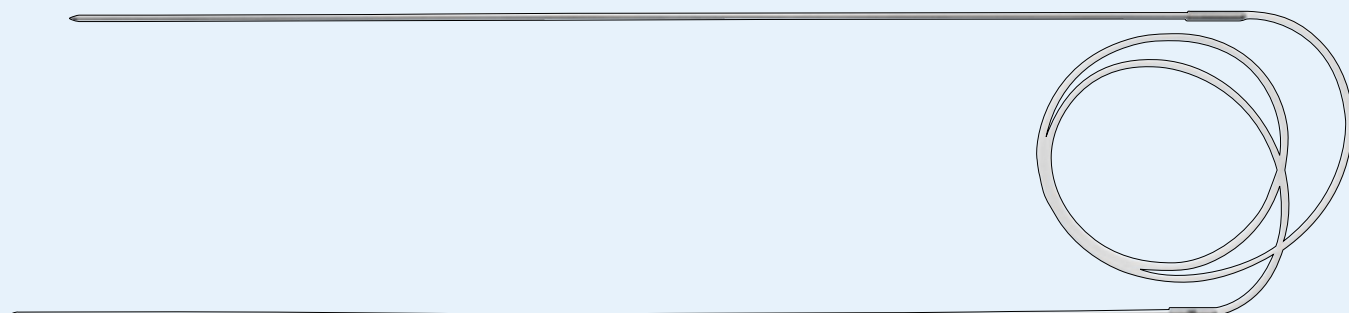
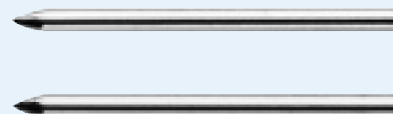

MA916R



INCHES

# Ophthalmic Instruments

## Cannulas

### CRAWFORD Lacrimal Intubation Set

MA922R

Two Olive-tipped 0.8 mm Probes Attached to 250 mm Long Silicone Tubing (Single-Use)

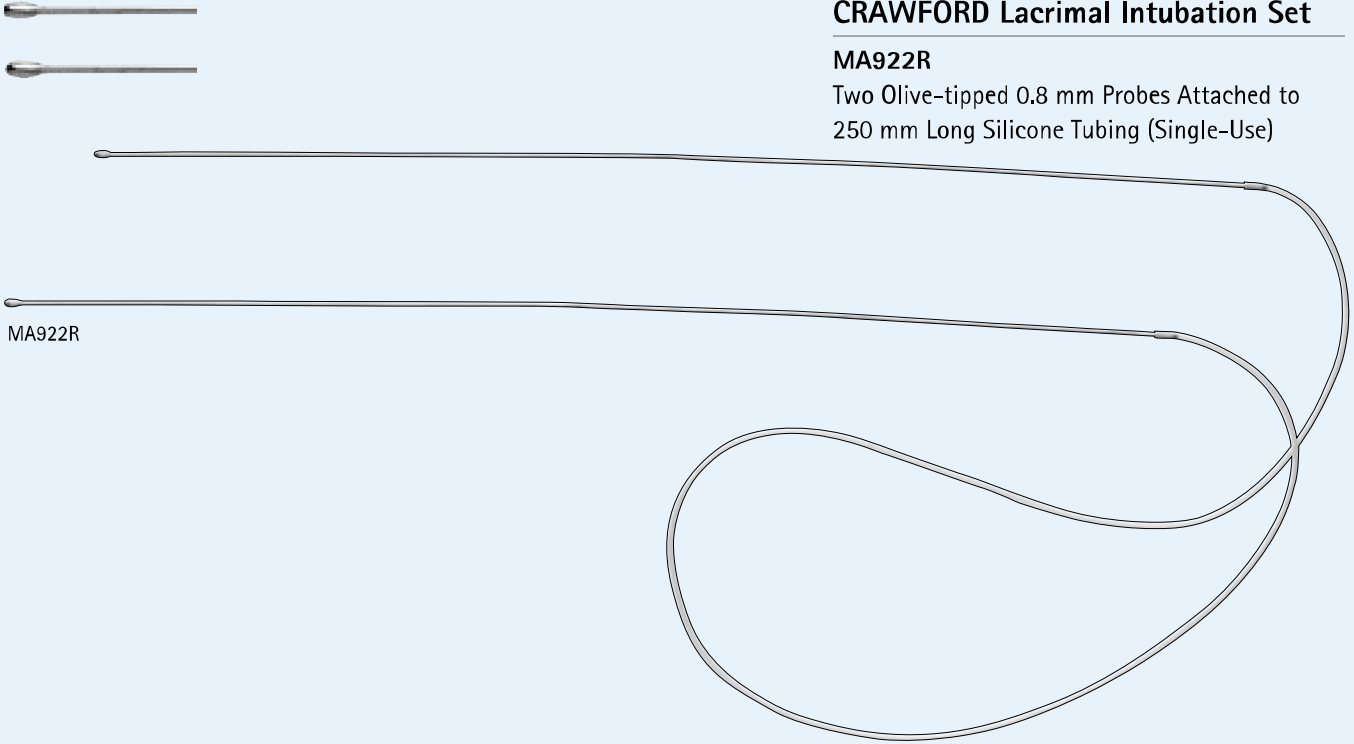

### CRAWFORD Retrieving Hook

MA923R

For Use with MA922R, 5 1/8"



## Lacrimal Cannulas

### MA925R

Straight, Reinforced, Malleable Tip, 23G, 1<sup>3</sup>/<sub>8</sub>"



### MA926R

Curved, Reinforced, Malleable Tip, 23G, 1<sup>3</sup>/<sub>8</sub>"



### MA959R

Straight, 23G, 1"

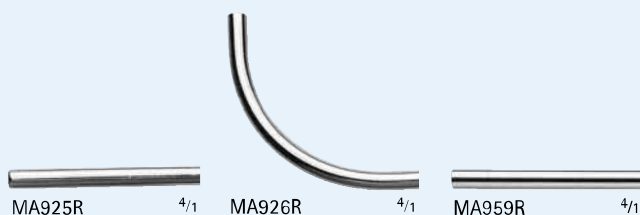
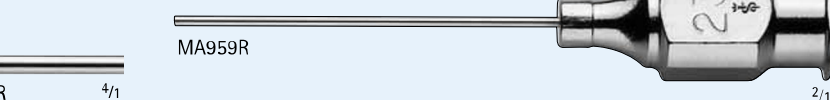

## SHAHINIAN Lacrimal Cannula

### MA927R

Straight, Blunt Tip, 0.3 mm Side Port, 23G, 3/8"

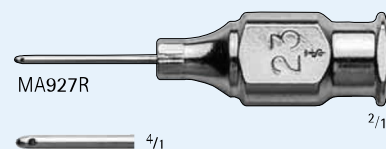

## RANDOLPH Cyclodialysis Cannula

### MA930R

Angled 13 mm from Tip, More Flattened, 19G, 1<sup>3</sup>/<sub>8</sub>"



MA930R 4/1



MA970R 4/1

### MA970R

Angled 13 mm from Tip, Flattened, 19G, 1<sup>1</sup>/<sub>4</sub>"

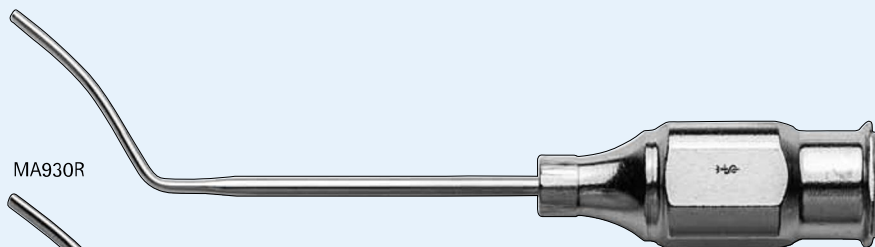

## TROUTMAN Olive Tip Cannula

### MA931R

Gently Curved, 1 mm Tip, 25G, 1"

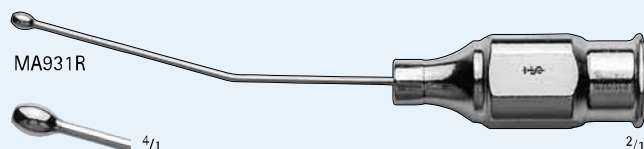

# Ophthalmic Instruments

## Cannulas

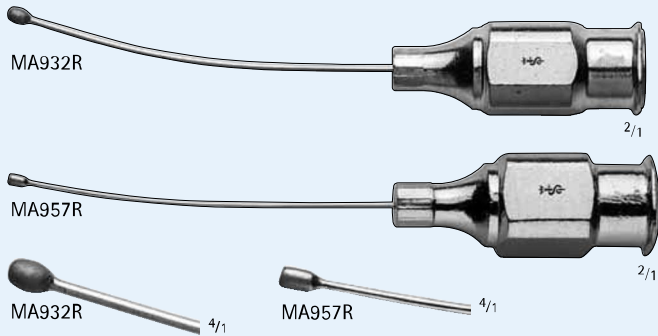

### JENSEN Capsule Polisher

**MA932R**

Curved, Roughened Tip, Front Opening, 25G, 1"

**MA957R**

Curved, Roughened Tip, Front Opening, 27G, 1"

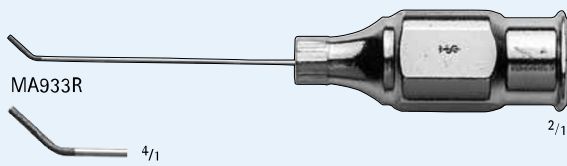

### KNOLLE Capsule Polisher

**MA933R**

2 mm Angled Tip, Roughened, 30G, 3/4"



### BISHOP-HARMON Anterior Chamber Irrigator Set

**MA934R**

Includes 19G Angled Cannula, Plastic Adaptor, Silicone Bulb

**MA935**

Silicone Bulb, 28 x 55 mm

**MA936**

Plastic Adaptor, For Use with MA935

**MA937R**

Cannula, Angled, 19G, 1"

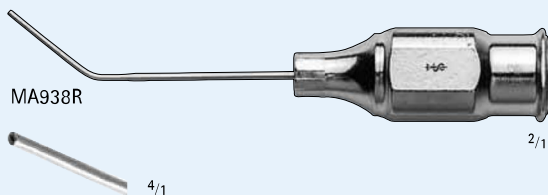

### Hydrodissection Cannula

**MA938R**

Angled, Flattened Tip, Front Opening, 25G, 3/4"

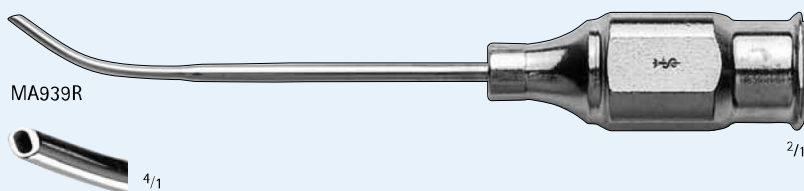

### BRACKEN Irrigating Cannula

**MA939R**

Curved, Flattened Beveled Tip, Front Opening, 19G, 1 1/4"

## SLADE LASIK Cannula

### MA940R

Angled, Flattened Spatula Tip, Front Opening,  
26G, 1/2"



## BURATTO Cannula

### MA941R

Angled, Slightly Flattened Valuted Tip, 1 Front &  
2 Sides Ports, 25G, 1"

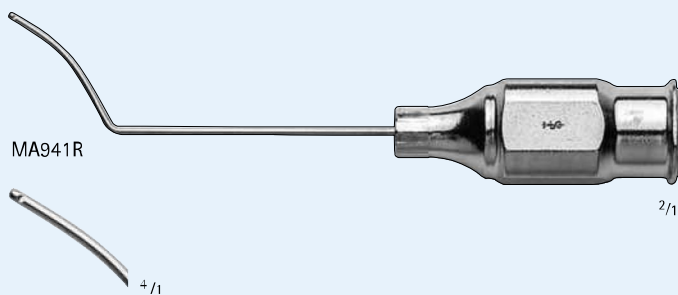

## MCINTYRE Anterior Chamber Cannulas

### MA942R

Angled 12 mm from Tip, Blunt Tip, 23G, 3/4"

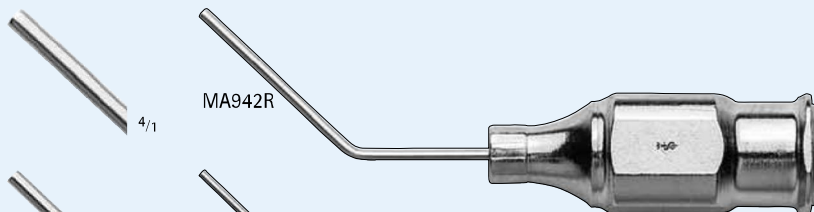

### MA943R

Angled 12 mm from Tip, Blunt Tip, 26G, 3/4"

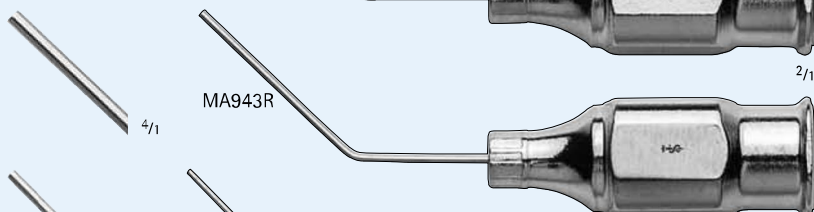

### MA944R

Angled 12 mm from Tip, Blunt Tip, 30G, 3/4"

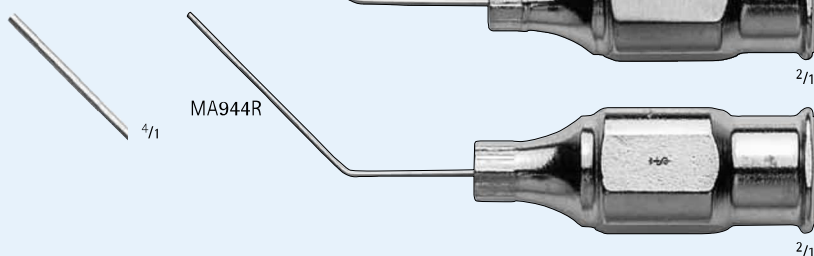

### MA962R

Straight, Blunt Tip, 23G, 3/4"

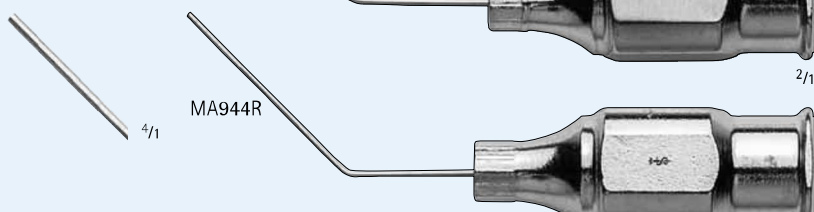

### MA963R

Straight, Blunt Tip, 26G, 3/4"

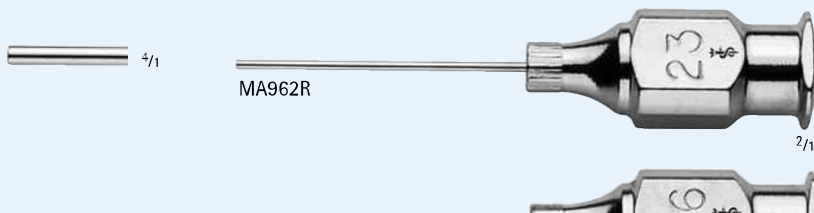

### MA964R

Straight, Blunt Tip, 30G, 3/4"

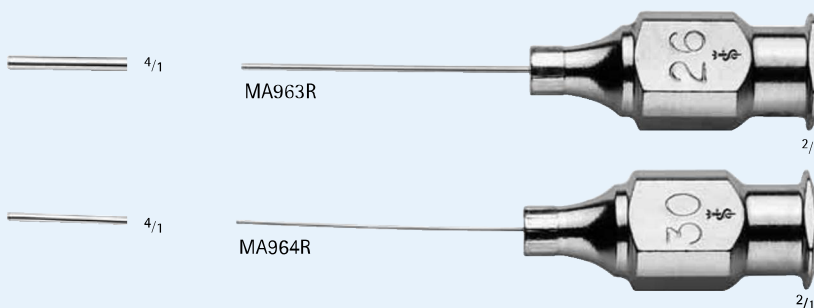

# Ophthalmic Instruments

## Cannulas

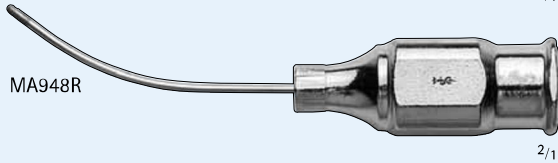
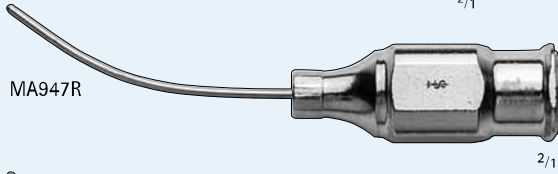
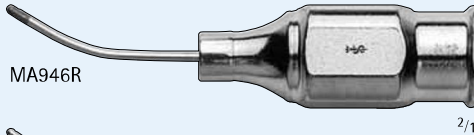
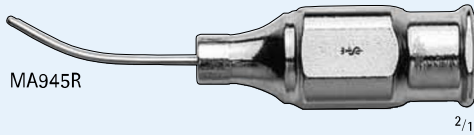

### SIMCOE Cortex Extractors

#### MA945R

Curved, Smooth Tip, 0.3 mm Side Port, 23G, 1/2"

#### MA946R

Curved, Roughened Tip, 0.3 mm Side Port, 23G, 1/2"

#### MA947R

Curved, Smooth Tip, 0.3 mm Side Port, 23G, 3/4"

#### MA948R

Curved, Roughened Tip, 0.3 mm Side Port, 23G, 3/4"

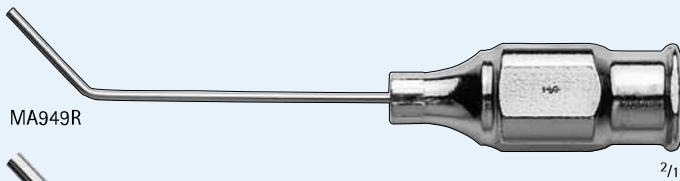

### MORRISON Aspirating Cannula

#### MA949R

Angled 7 mm from Tip, Smooth Blunt Tip, Front Opening, 23G

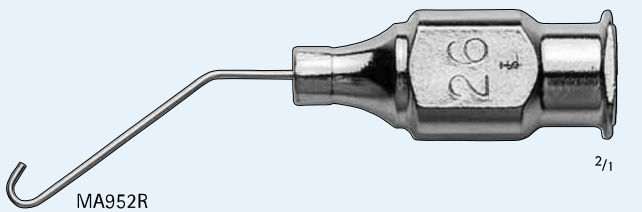
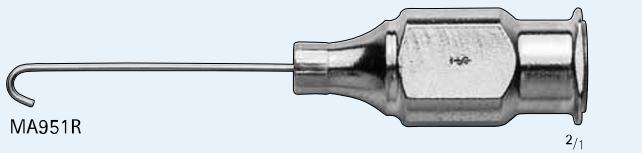
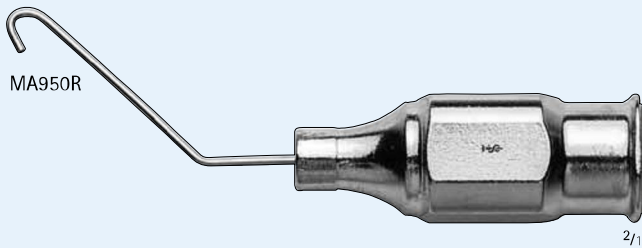

### MCINTYRE-BINKHORST Cannulas

#### MA950R

Straight, Smooth Blunt Hook-Shaped Tip, Front Opening, 26G, 3/4"

#### MA951R

Right Angled, Smooth Blunt Hook-Shaped Tip, Front Opening, 26G, 3/4"

#### MA952R

Left Angled, Smooth Blunt Hook-Shaped Tip, Front Opening, 26G, 3/4"

# Cannulas

## CHANG Nucleus Hydrodissector Cannula

MA953R

Angled 90°, Flat Tip, Beveled Opening, 27G, 1/2"

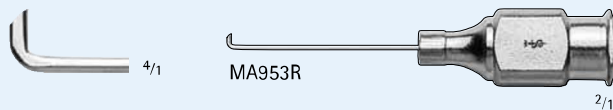

## ATKINSON Retrobulbar Needle

MA954R

23G, 1 3/8"



## KELMAN Cystotome

MA955R

22G, 1 1/4"

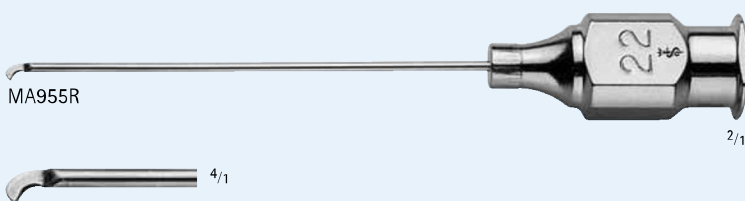

## KRATZ Capsule Scrubber

MA956R

Angled, Roughened, 23G, 3/4"

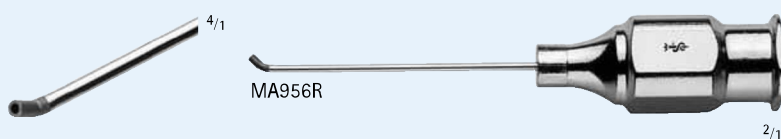

## Backflush Infusion Cannula

MA958R

23G, 1 3/8"



## NICHAMIN Hydrodissection Cannula

MA960R

25G

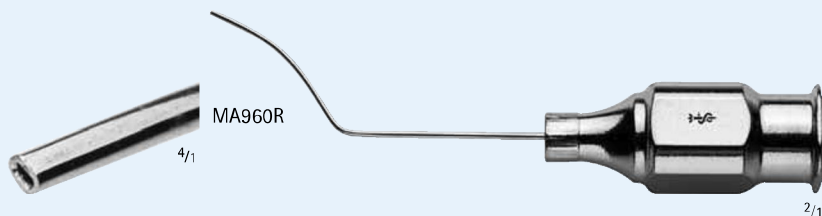

# Ophthalmic Instruments

## Cannulas

### SIMCOE Irrigating Aspirating Unit

**MA965R**

23G, Apiration Through 0.3 mm Top Port, Irrigation Through Front Port, uses 225 mm Tubing

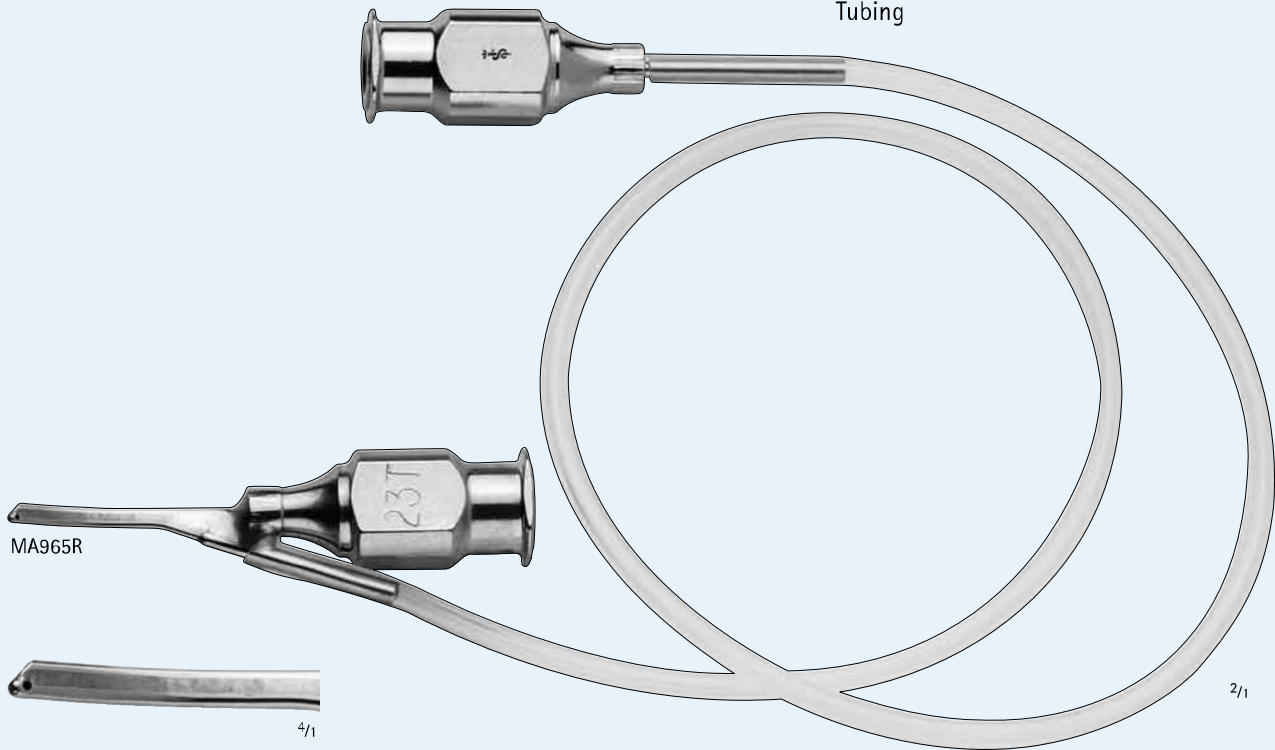

### WEST LACRIMAL CANNULA

**MA968R**

0.3 mm Side Port, 23G, 1 1/4"

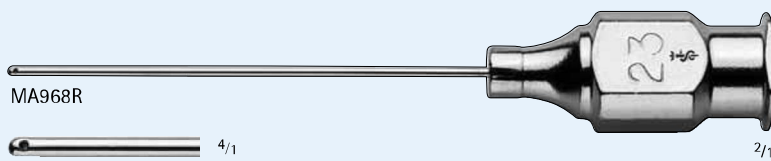

### Air Injection Cannulas

**MA640R**

27 Gauge, Angled Tip, 5 mm Tip to Bend, 3/4"

**MA641R**

30 Gauge, Angled Tip, 5 mm Tip to Bend, 3/4"

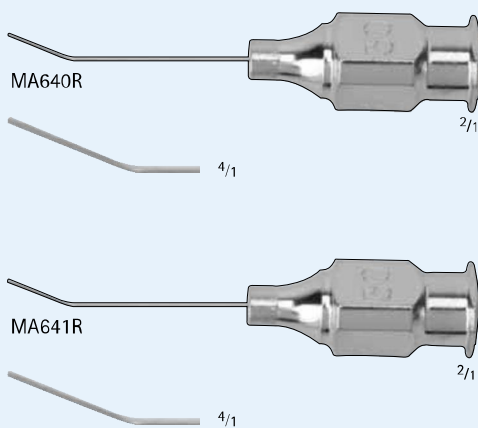





### Corneal Dissector Knife

MA767R

Angled Blade, Curved Tip, 4 1/2"

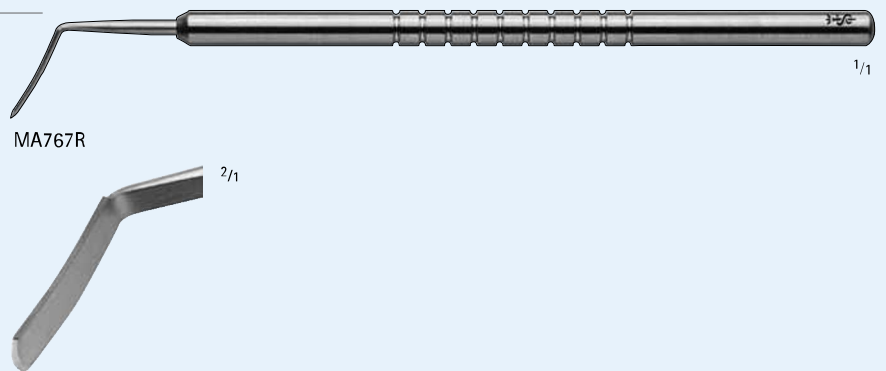

### TOOKE Corneal Knife

MA773R

Straight, 3 mm x 18 mm Blade, Curved Cutting Edge, 4 3/4"

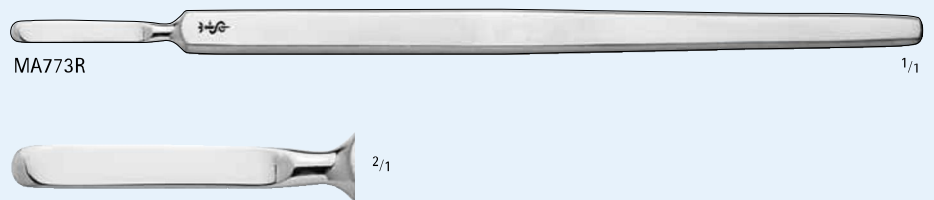

### KELLY DESCEMET'S Membrane Punch

MA771R

1 mm Diameter Tip, 5 1/8"

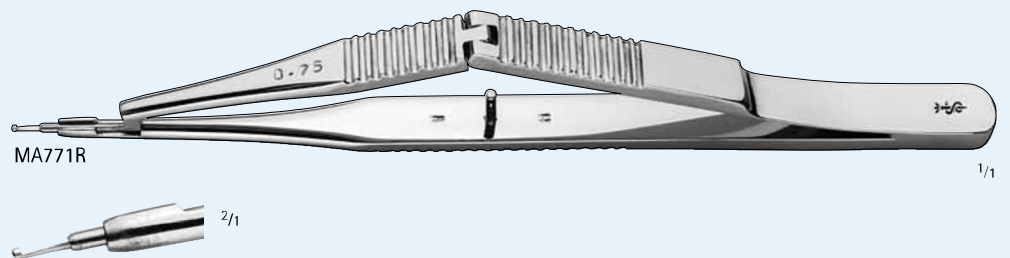

### CARTER Sphere Introducer

MA974R

5"

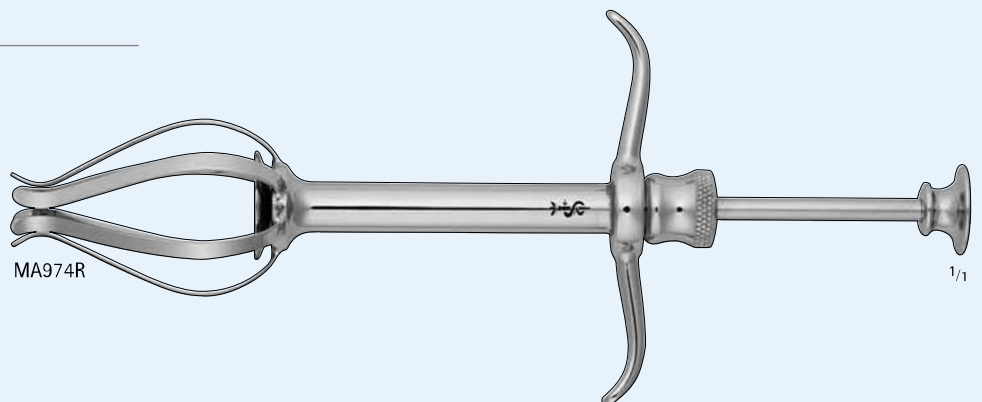

# Ophthalmic Instruments

## Index

Item No.	Page	Item No.	Page	Item No.	Page	Item No.	Page	Item No.	Page	Item No.	Page
BC004R	31	FD020R	30	MA199R	40	MA477R	35	MA640R	56	MA763R	6
BC005R	31	FD021R	30	MA200R	40	MA478R	35	MA641R	56	MA764R	6
BC008R	32	FD100R	30	MA201R	40	MA479R	35	MA726R	43	MA765R	8
BC009R	32	FD101R	30	MA316R	41	MA480R	35	MA731R	8	MA766R	8
BC010R	32	FD103R	30	MA317R	41	MA483R	29	MA732R	23	MA767R	57
BC011R	32	FD230R	45	MA351R	45	MA484R	29	MA733R	23	MA771R	57
BC020R	33	FD231R	45	MA352R	45	MA485R	29	MA734R	23	MA773R	57
BC021R	33	FD232R	45	MA353R	45	MA486R	29	MA735R	23	MA775R	20
BC050R	31	FD233R	45	MA354R	45	MA487R	30	MA736R	23	MA776R	14
BC164R	33	FD242R	46	MA355R	46	MA548R	41	MA737R	23	MA777R	10
BC165R	33	FD243R	46	MA356R	46	MA612R	29	MA738R	23	MA778R	10
BC170R	32	MA001R	4	MA357R	45	MA613R	30	MA739R	23	MA779R	10
BC171R	32	MA002R	4	MA358R	45	MA614R	30	MA740R	23	MA780R	11
BC172R	32	MA005R	4	MA360R	45	MA617R	41	MA741R	23	MA781R	11
BC173R	32	MA148R	38	MA362R	47	MA618R	38	MA742R	23	MA782R	11
BC186R	32	MA149R	38	MA363R	46	MA619R	41	MA743R	23	MA783R	11
BC187R	32	MA150R	38	MA364R	46	MA620R	41	MA744R	9	MA784R	11
BC194R	32	MA151R	38	MA366R	46	MA621R	42	MA745R	9	MA785R	12
BC195R	32	MA152R	38	MA367R	46	MA622R	42	MA747R	9	MA786R	12
BC210R	33	MA153R	38	MA368R	46	MA623R	43	MA749R	8	MA789R	12
BC211R	33	MA154R	38	MA407R	48	MA624R	42	MA750R	6	MA790R	12
BC211W	33	MA155R	39	MA410R	48	MA625R	42	MA751R	5	MA791R	13
BC256R	33	MA157R	39	MA411R	48	MA626R	43	MA752R	5	MA792R	13
BC257R	33	MA158R	38	MA412R	48	MA628R	46	MA754R	5	MA793R	13
BC257W	33	MA166R	39	MA413R	48	MA630R	17	MA755R	5	MA794R	13
BC628R	34	MA167R	39	MA414R	48	MA631R	19	MA756R	5	MA795R	13
BD330R	40	MA170R	40	MA434R	8	MA632R	21	MA757R	5	MA796R	14
BD331R	40	MA171R	40	MA435R	8	MA633R	21	MA758R	6	MA797R	14
BD333R	40	MA195R	40	MA436R	8	MA634R	21	MA759R	6	MA798R	15
BD335R	40	MA196R	40	MA437R	8	MA635R	21	MA760R	6	MA799R	15
BM560R	45	MA197R	40	MA475R	34	MA636R	21	MA761R	9	MA800R	22
BM562R	45	MA198R	40	MA476R	35	MA637R	15	MA762R	6	MA801R	16

Item No.	Page	Item No.	Page	Item No.	Page	Item No.	Page	Item No.	Page	Item No.	Page
MA803R	16	MA838R	24	MA873R	27	MA922R	50	MA956R	55	OC022R	44
MA804R	17	MA839R	24	MA874R	34	MA923R	50	MA957R	52	OC024R	44
MA805R	16	MA840R	24	MA875R	36	MA924R	22	MA958R	55	OC025R	44
MA806R	16	MA841R	24	MA876R	36	MA925R	51	MA959R	51	OC026R	44
MA807R	17	MA842R	25	MA878R	39	MA926R	51	MA960R	55	OC051R	44
MA808R	17	MA843R	25	MA879R	43	MA927R	51	MA962R	53	OC091R	44
MA809R	18	MA844R	25	MA880R	43	MA930R	51	MA963R	53	OC094R	38
MA810R	18	MA845R	25	MA881R	41	MA930R	51	MA964R	53	OC100R	44
MA811R	18	MA846R	25	MA885R	37	MA932R	52	MA965R	56	OC430R	34
MA812R	18	MA847R	26	MA886R	36	MA933R	52	MA968R	56	OC480R	30
MA813R	19	MA848R	26	MA888R	36	MA934R	52	MA970R	51	OC482R	30
MA814R	19	MA849R	26	MA891R	37	MA935	52	MA971R	22	OC485R	31
MA815R	19	MA850R	25	MA892R	37	MA936	52	MA974R	57	OC486R	31
MA816R	19	MA851R	25	MA896R	37	MA937R	52	MA975R	23	OC491R	31
MA817R	20	MA852R	26	MA897T	42	MA938R	52	MB477R	38	OC492R	31
MA818R	20	MA853R	26	MA898T	38	MA939R	52	MB791R	4	OC496R	30
MA819T	18	MA854R	26	MA899R	44	MA940R	53	MD580	44	OC497R	30
MA820R	20	MA855R	26	MA900R	44	MA941R	53	OA200R	5	OC498R	31
MA821R	20	MA856R	27	MA901R	39	MA942R	53	OA218R	7	OC499R	31
MA822T	14	MA857R	27	MA902R	44	MA943R	53	OA225R	7	OC500R	31
MA823R	22	MA858R	27	MA907R	46	MA944R	53	OA310R	7	OK366R	32
MA824R	17	MA859R	27	MA908R	47	MA945R	54	OA311R	7		
MA825T	18	MA860R	27	MA909R	47	MA946R	54	OA312R	7		
MA826T	19	MA861R	28	MA910R	47	MA947R	54	OA313R	7		
MA827T	19	MA862R	28	MA911R	47	MA948R	54	OA314R	7		
MA828R	21	MA864R	28	MA915R	49	MA949R	54	OB510	48		
MA829R	23	MA865R	28	MA916R	49	MA950R	54	OB511	48		
MA833R	24	MA866R	28	MA917R	47	MA951R	54	OB512	48		
MA834R	24	MA867R	29	MA918R	48	MA952R	54	OB513	48		
MA835R	24	MA868R	29	MA919R	48	MA953R	55	OB514	48		
MA836R	24	MA870R	29	MA920R	48	MA954R	55	OC020R	44		
MA837R	24	MA871R	36	MA921R	47	MA955R	55	OC021R	44		



